



Metasol Meta Solution

MCCB/ELCB

Molded Case Circuit Breakers
Earth Leakage Circuit Breakers



LSIS

Contents

1-1 ~ 1-18	Marking and configuration / External configuration
2-1 ~ 2-10	Quick selection table (Molded Case Circuit Breakers)
3-1 ~ 3-4	Quick selection table (Earth Leakage Circuit Breakers)
4-1 ~ 4-2	Type numbering system
5-1 ~ 5-22	Ratings (Molded Case Circuit Breakers)
6-1 ~ 6-18	Ratings (Earth Leakage Circuit Breakers)
7-1 ~ 7-26	Accessories
8-1 ~ 8-9	Characteristics curves
9-1 ~ 9-18	Dimensions
10-1 ~ 10-16	Technical information

Metasol *Meta Solution*

MCCB / ELCB

Molded Case Circuit Breakers / Earth Leakage Circuit Breakers



**Upgraded for the
global best worth!**

LSIS will become a global leader in electric power solutions.



Metasol
ABS 203c

250AF	3P
Ue	Ics=Icu
690V	8kA
480/500V	25kA
415/460V	35kA
380V	35kA
220/240V	85kA
250V	20kA
125V	30kA

Ics = 100%Icu
 50/60Hz
 Cat. A

CE
 IEC60947-2
 LS IS
 MADE IN KOREA

MCCB
 Uimp 8kV
ZCT

LS



Metasol

Meta solution



Metasol	
ABS 203c	
250AF	3P
Ue	
690V	
480/500V	
415/460V	~ Ics=Icu
380V	~ 8kA
220/240V	~ 26kA
500V	~ 37kA
250V	~ 42kA
Ics = 100%Icu	85kA
50/60Hz	20kA
Cat. A	20kA

CE
IEC60947-2
LS IS
MADE IN KOREA

MCCB = ELCB

Metasol

Molded Case Circuit Breaker / Earth Leakage Circuit Breaker

Upgrade of Meta-MEC series

... **Metasol** Low Voltage Circuit Breaker

- $U_i = 1000V$
- $U_{imp} = 8kV$



- ***Compatible and differentiated design***

- Compatible with the Meta-MEC
- Outlook differentiated design

- ***Same external dimension with MCCB and ELCB***

- ***Upgrade the coordination***

- Upgrade the coordination with Susol / Meta-MEC mass capacity

- ***Upgrade breaking capacity***

- N100AF : 10 ➔ 18kA
- S125AF : 25 ➔ 37kA
- S250AF : 25 ➔ 37kA
- H250AF : 35 ➔ 50kA
- N400AF : 25 ➔ 37kA
- S400AF : 35 ➔ 50kA
- S800AF : 50 ➔ 65kA

Metasol MCCB/ELCB



Metasol MCCB

Upgrade breaking capacity

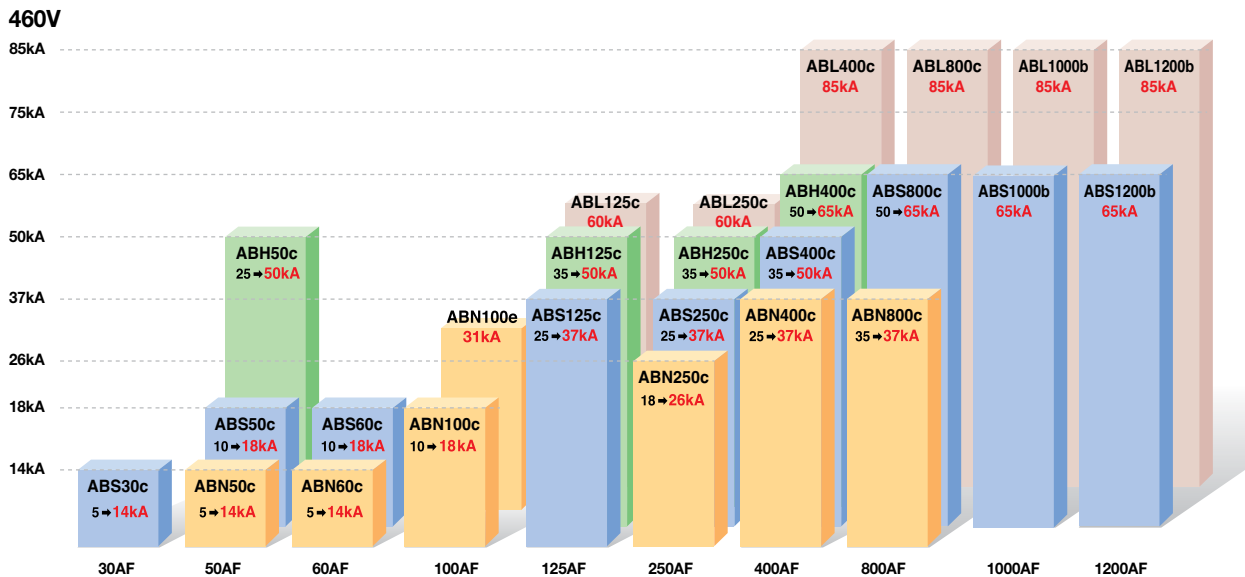

Short-circuit breaking capacity

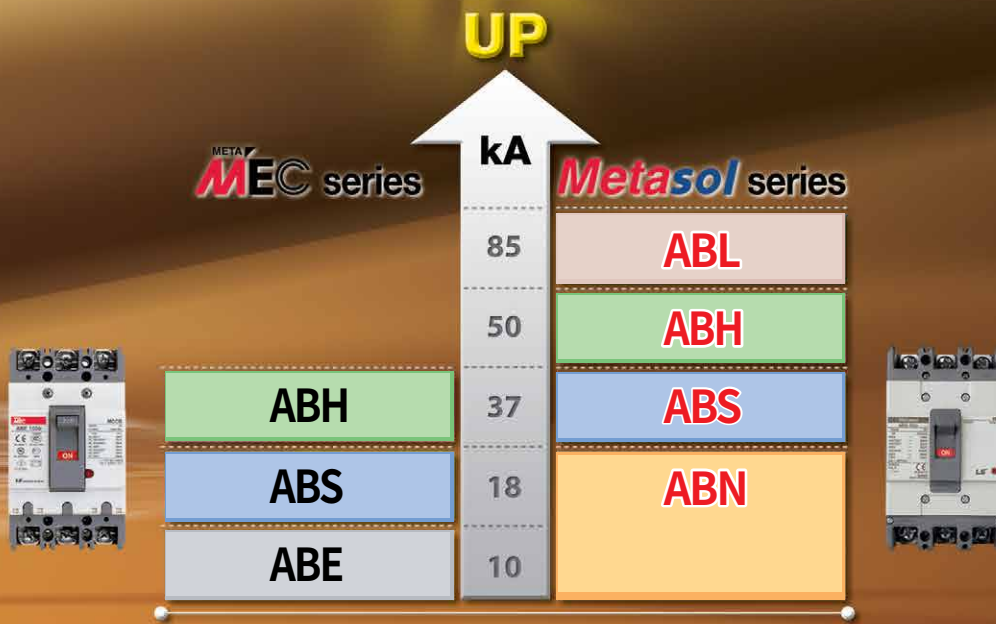

Upgrade breaking capacity

- N100AF :
10 → **18kA**
- S125AF :
25 → **37kA**
- S250AF :
25 → **37kA**
- H250AF :
35 → **50kA**
- N400AF :
25 → **37kA**
- S400AF :
35 → **50kA**
- S630AF :
50 → **65kA**
- S800AF :
50 → **65kA**

Metasol ELCB

Upgrade breaking capacity

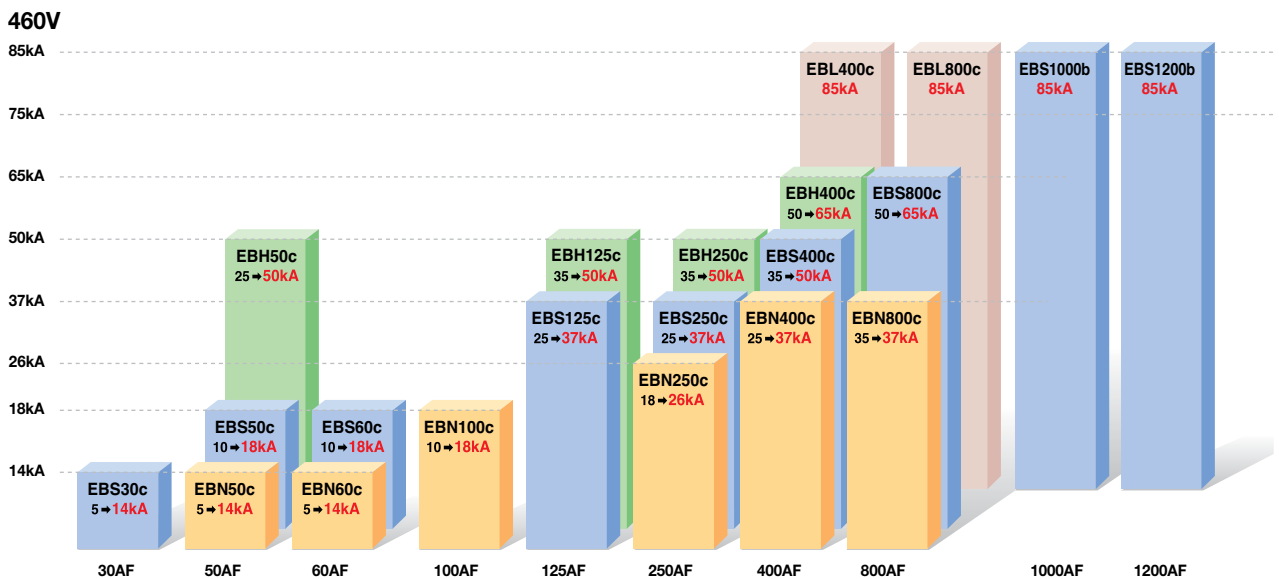

Metasol MCCB/ELCB Compatible and standard

- 100% compatible with Meta-MEC series.
- Standardized dimension (Depth, cutout) when the panel is made.

MCCB (Molded Case Circuit Breaker)



105 × 165 × 60mm



90 × 155 × 60mm



75 × 130 × 60mm

Metasol MCCB

AF Type	30AF	50AF	60AF	100AF	125AF	250AF	400AF	800AF	1000AF	1200AF
ABN		ABN50c 14kA	ABN60c 14kA	ABN100c 18kA ABN100d 26kA ABN100e 31kA		ABN250c 26kA	ABN400c 37kA	ABN800c 37kA		
ABS	ABS30c 14kA	ABS50c 18kA	ABS60c 18kA		ABS125c 37kA	ABS250c 37kA	ABS400c 50kA	ABS800c 65kA	ABS1000b 65kA	ABS1200b 65kA
ABH		ABH50c 50kA			ABH125c 50kA	ABH250c 50kA	ABH400c 65kA			
ABL					ABL125c 60kA	ABL250c 60kA	ABL400c 85kA	ABL800c 85kA	ABL1000b 85kA	ABL1200b 85kA

Note) Dimension is for 3 pole and breaking capacity is for AC460V.

- Same external dimension with MCCB and ELCB.

ELCB (Earth Leakage Circuit Breaker)



Metasol ELCB

AF Type	30AF	50AF	60AF	100AF	125AF	250AF	400AF	800AF	1000AF	1200AF
EBS	EBS30c 14kA	EBS50c 18kA	EBS60c 18kA		EBS125c 37kA	EBS250c 37kA	EBS400c 50kA	EBS800c 65kA	EBS1000b 85kA	EBS1200b 85kA
EBN		EBN50c 14kA	EBN60c 14kA	EBN100c 18kA		EBN250c 26kA	EBN400c 37kA	EBN800c 37kA		
EBH		EBH50c 50kA			EBH125c 50kA	EBH250c 50kA	EBH400c 65kA			
EBL							EBL400c 85kA	EBL800c 85kA		

Note) Dimension is for 3 pole and breaking capacity is for AC460V.

Metasol MCCB/ELCB System overview

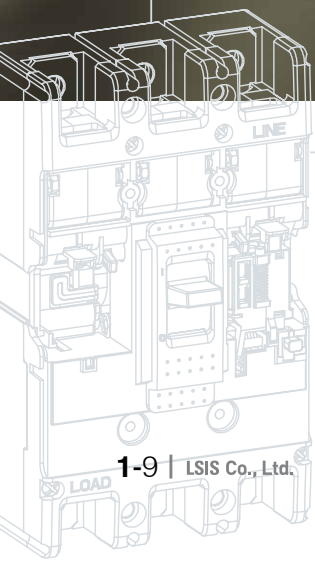

■ Various installable accessories

- Wider range of installable accessories compared to Meta MEC series.
- Composed of user friendly method.

System overview

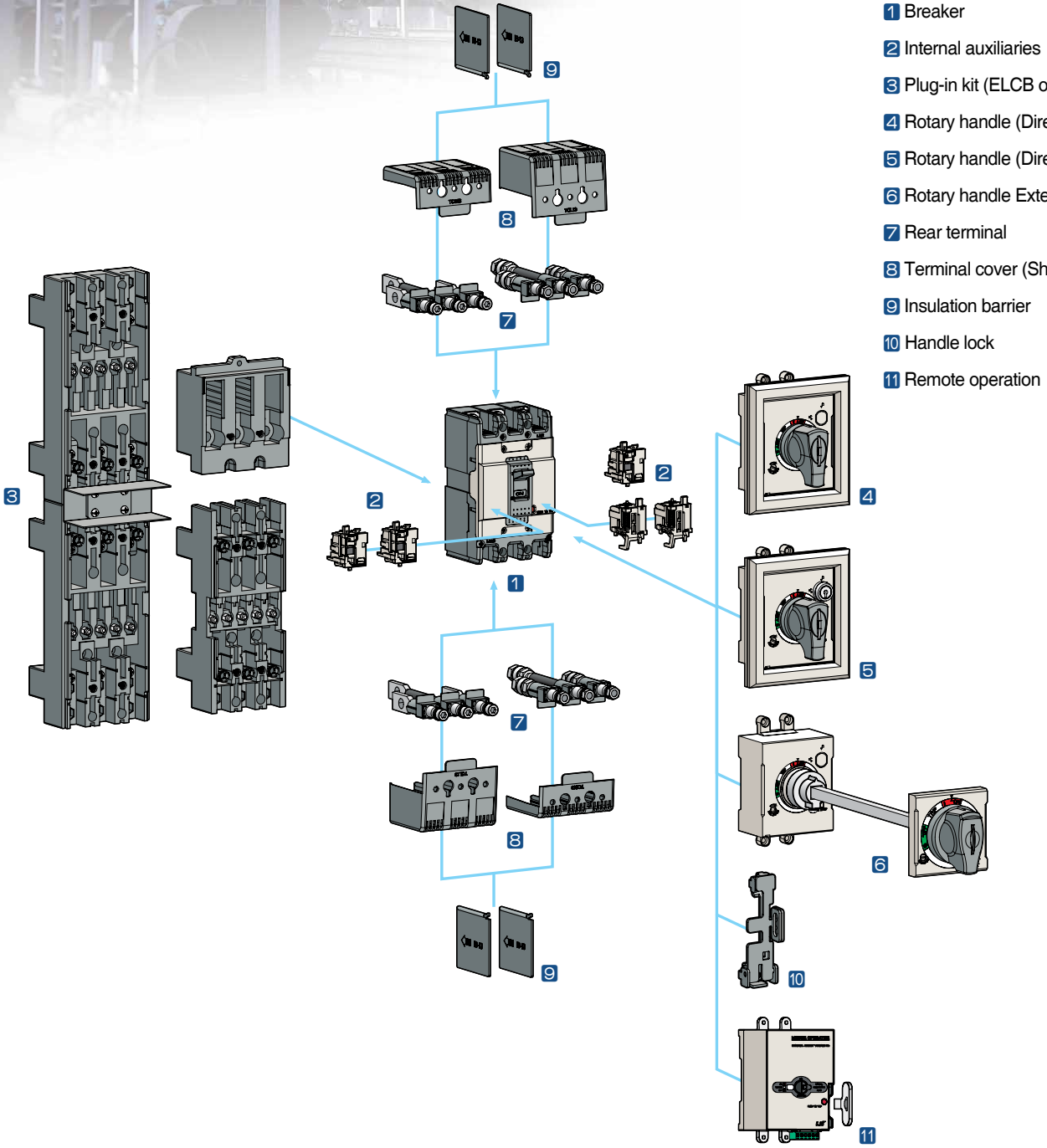

Metasol MCCB/ELCB Internal accessories

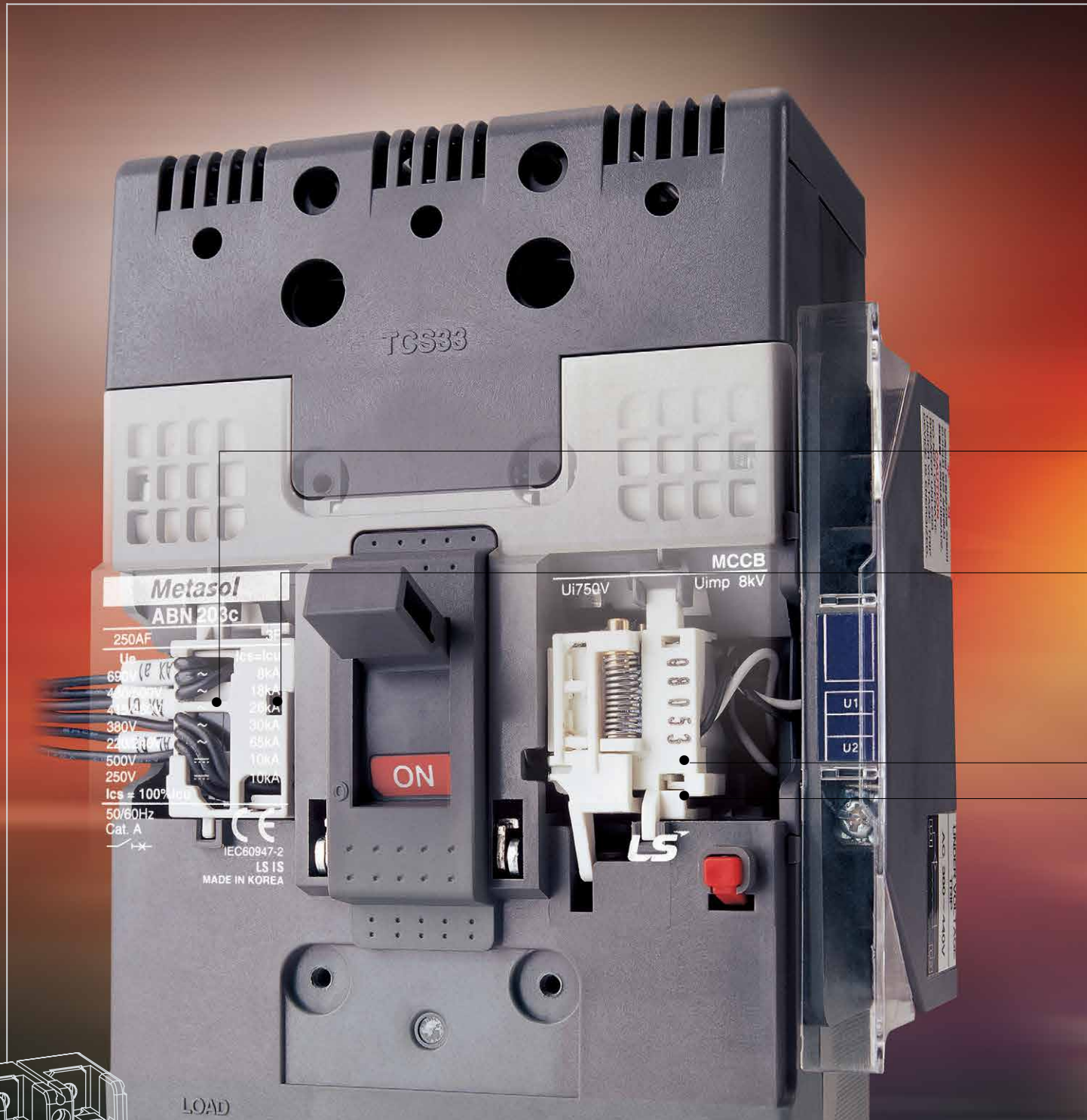

Internal accessories

Internal accessories can be commonly used in all Metasol MCCB and ELCB
(Notice: Exception of SHT, UVT in ELCB)

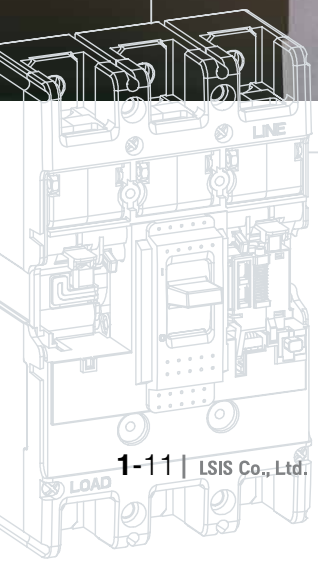

Common use to all Metasol MCCBs and ELCBs



Alarm switch (AL)

Alarm switches offer provisions for immediate audio or visual indication of a tripped breaker due to overload, short-circuit, operation of shunt trip, or undervoltage trip conditions, operation of push button.

They are particularly useful in automated plants where operators must be signaled about changes in the electrical distribution system. This switch features a closed contact when the circuit breaker is tripped automatically. In other words, this switch does not function when the breaker is operated manually. Its contact is open when the circuit breaker is reset.



Auxiliary switch (AX)

Auxiliary switch is for applications requiring remote "On" and "Off" indication. Each switch contains two contacts having a common connection. One is open and the other closed when the circuit breaker is open, and vice-versa.



Undervoltage trip (UVT)

The undervoltage trip automatically opens a circuit breaker when voltage drops to a value ranging between 35% to 70% of the line voltage. The operation is instantaneous, and the circuit breaker cannot be reclosed until the voltage returns to 85% of line voltage.

Continuously energized, the undervoltage trip must be operating before the circuit breaker can be closed.



Shunt trip (SHT)

The shunt trip opens the mechanism in response to an externally applied voltage signal. LS shunt trips include coil clearing contacts that automatically clear the signal circuit when the mechanism has tripped. contact with live parts and thereby guarantee protection against direct contacts.

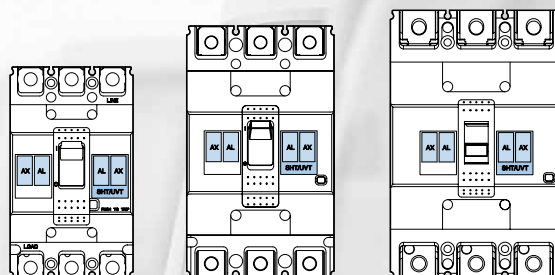

Metasol MCCB/ELCB External accessories

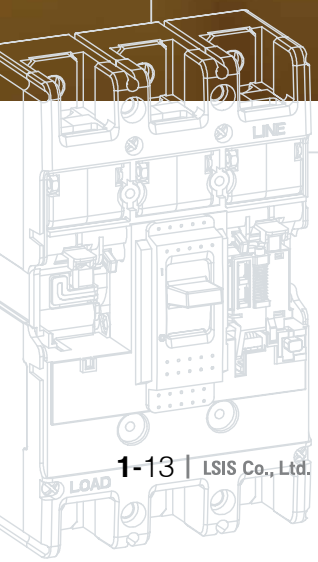

External accessories

Designed for various mount and user safety.



Front and rear connection

Several kinds of terminals can be equipped with ELCBs as well as MCCBs.

- Terminals for front connection
- Rear connection terminals

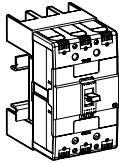

Plug-in base

It makes to extract and/or rapidly replace the circuit breaker without having to touch connections. (Easy replacement and maintenance)

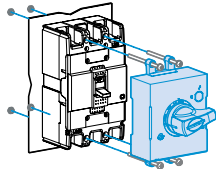

Direct & extended rotary handle

There are two types of rotary handles.

- Direct rotary handle (with or w/o key lock device)
- Extended rotary handle

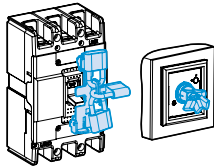

Locking device

- Fixed padlock
- Removable padlock
- Key lock device on direct handle

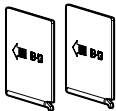

Insulation barrier

These allow the insulation characteristics between the phases at the connections to be increased.

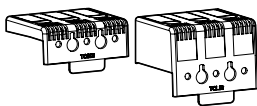

Insulation terminal cover

The terminal covers are applied to the circuit-breaker to prevent accidental contact with live parts and thereby guarantee protection against direct contacts.

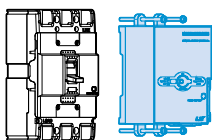

Remote operation

It is a device that makes it possible to turn On / Off the breaker even in the remote place. It is safe because it does not have to operate the handle of the circuit breaker by hand, and it is suitable for automation.

Marking and configuration

MCCB

- MCCB model**
- ABN: Economic type
 - ABS: Standard type
 - ABH: High capacity type
- Standardized characteristics**
- Ui: Rated insulation voltage
 - Uimp: Impulse withstand voltage
 - Ue: Rated operational voltage
 - Icu: Ultimate breaking capacity
 - Ics: Service breaking capacity



Rated frequency

Utilization category

Manufacturer

Standard

Symbol indicating suitability for isolation as defined by IEC 947-2

MCCB

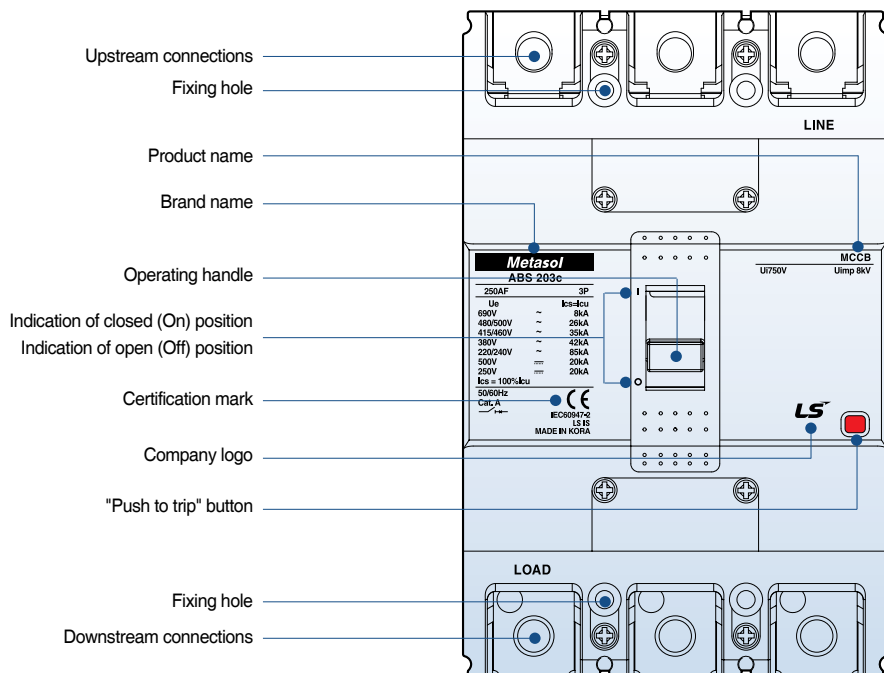

ELCB



- ELCB model**
- EBN: Economic type
 - EBS: Standard type
 - EBH: High capacity type

Rated frequency

Standard

Manufacturer

Utilization category

Symbol indicating suitability for isolation as defined by IEC 947-2

ELCB

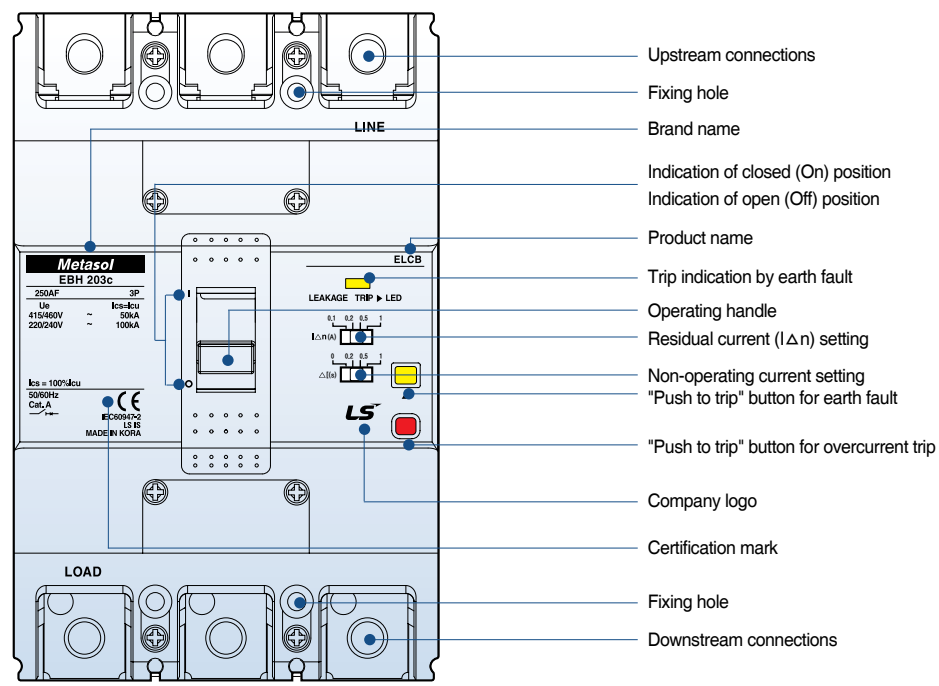

External configuration

MCCB

① Handle

- Function of indications
- "On" "Off" "Trip"
- Resetting
- When the handle indicates "Tripped" position it must first be reset by moving the handle to the "Off" position and then closing is possible
- Trip-free even if the handle is held at "On", the Breaker will trip if an over current flows
- Suitable for verification of the main contact position under abnormal conditions because the handle doesn't indicate open position

② Arc-Extinguishing unit

- LS patent technique PASQ
- Arc-extinguishing unit
- PASQ : Puffer assisted self-quenching
- Reduction of arc voltage for a short time

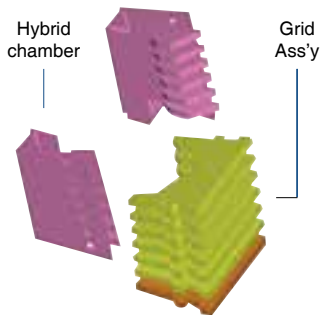

③ Trip button (Push to trip)

- Enables tripping mechanically from outside, for confirming the operation of the accessory switches and the manual resetting function.

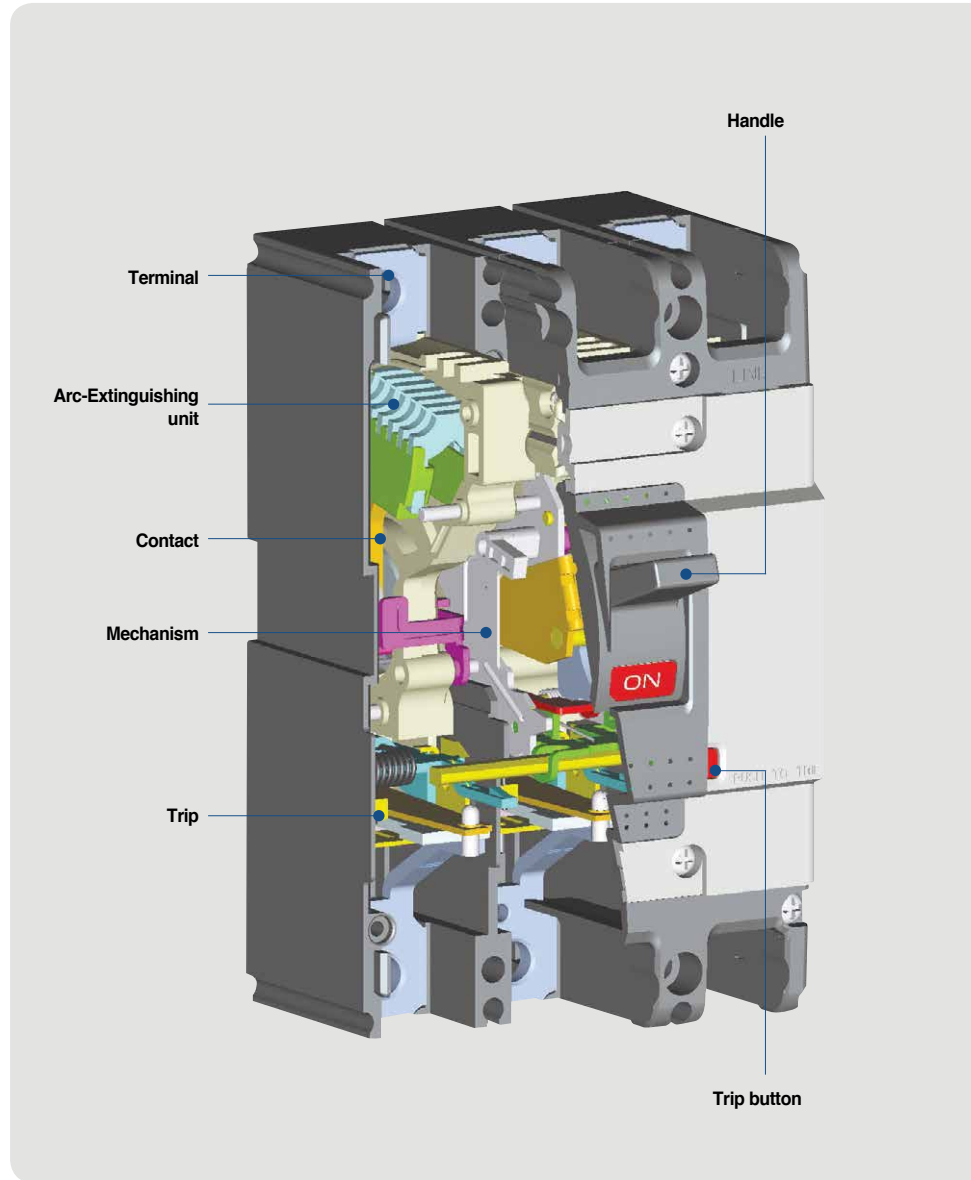

A application of PASQ arc extinguishing

• The reduction of breaking time by applying PASQ arc extinguishing for inhibition of arc voltage for a short time.

1 : Grid
2 : Contact
3 : Expansion Chamber(E-Chamber)
4 : Arc Chamber(Compression Chamber)

A application of current limiting structure

- Current limiting repulsion structure (U fixed structure)
- Toggle structure
- When the operating unit repulses by short circuit current, repulsion structure at bigger angle.

ELCB

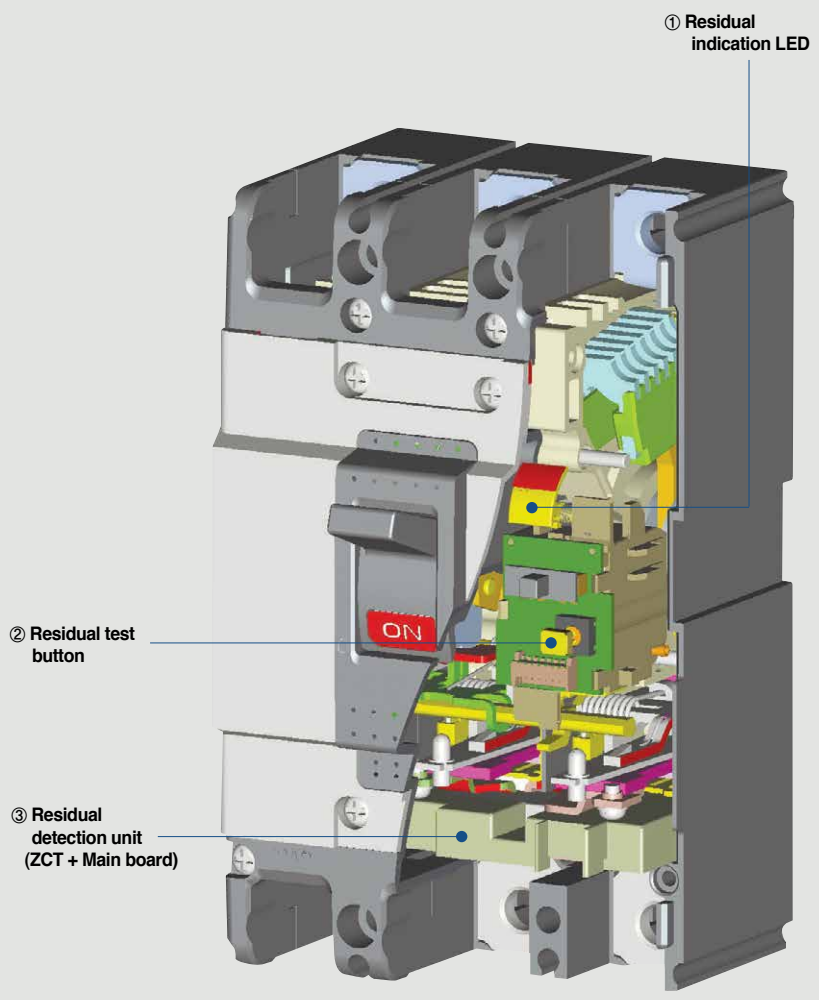

- ① **Residual indication LED**
 - Normal situation is yellow, trio situation is red

- ② **Residual test button**
 - Special design for upgrade to prohibit resistance accident

- ③ **Residual detection unit (ZCT + Main board)**
 - For upgrade the design is selected the 3 phase input power method and in case of voltage problem, it can break residual current safely.

Upgrade coil operation by special design



- Sliding structure application of trip lever
- Trip special design by applying design button method.
- Upgrade the testing unit

3 phase power supply method

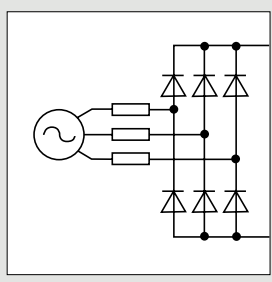

- In case of 1 phase loss residual operation upgrade
- New IEC standard

Quick selection table

Molded Case Circuit Breakers



MCCBs

AF		30AF		50AF			60AF	
Type		E-type	S-type	N-type	S-type	H-type	N-type	S-type
Type and pole	2-pole	ABE32b	ABS32c	ABN52c	ABS52c	ABH52c	ABN62c	ABS62c
	3-pole	ABE33b	ABS33c	ABN53c	ABS53c	ABH53c	ABN63c	ABS63c
	4-pole	-	ABS34c	ABN54c	ABS54c	ABH54c	ABN64c	ABS64c
Rated current, I _n	A	(3, 5, 10) ^{Note 1} , 15, 20, 30		15, 20, 30, 40, 50			15, 20, 30, 40, 50, 60	
Rated operational voltage, U _e	AC (V)	460	690	690	690	690	690	690
	DC (V)	-	500	500	500	500	500	500
Rated insulation voltage, U _i	V	460	1000	1000	1000	1000	1000	1000
Rated impulse withstand voltage, U _{imp}	kV	6	8	8	8	8	8	8

Rated short-circuit breaking capacity (I_{cu}) kA (Sym) , IEC 60947-2

AC	690V	-	2.5	2.5	5	10	2.5	5
	480/500V	-	7.5 (5)	7.5	10	35	7.5	10
	415/460V	2.5	14 (10)	14	18	50	14	18
	380V	2.5	18 (14)	18	22	50	18	22
	220/250V	5	30 (25)	30	35	100	30	35
DC	500V (3P)	-	5	5	10	30	5	10
	250V (2P)	-	5	5	10	30	5	10
I _{cs} =% × I _{cu}		50	100	100	100	100	100	100
Dimensions (mm)	W×H×D	75×96×60mm	75×130×60mm	75×130×60mm		90×155×60mm	75×130×60mm	
	(3-pole)		(Fig. 1)	(Fig. 1)		(Fig. 2)	(Fig. 1)	

* For more detail see the page. Ratings 5-1page - 5-14page, Curves 8-1page - 8-3page, and Drawings 9-1page - 9-4page

Note) 1. The short-circuit breaking capacities of ABS30AF type in () are applied to the rated current in (3, 5, 10A)

2. MCCBs can be applied to both 50 and 60Hz.

3. Standard type is designed on the basis of 40°C of ambient temperature.

4. There are certain products for hot areas, (30-250AF on the basis of 55°C)

5. The I_{cs}(service breaking capacity) of ABN100e, ABL125/250AF are in ()

AF Type	30AF	50AF	60AF	100AF	125AF	250AF
ABN		ABN50c 14kA	ABN60c 14kA	ABN100c 18kA ABN100e 31kA		ABN250c 26kA
ABS	ABS30c 14kA	ABS50c 18kA	ABS60c 18kA		ABS125c 37kA	ABS250c 37kA
ABH		ABH50c 50kA			ABH125c 50kA	ABH250c 50kA
ABL					ABL125c 60kA	ABL250c 60kA

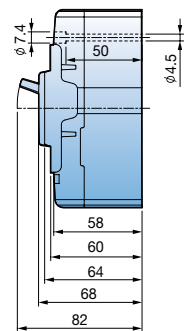
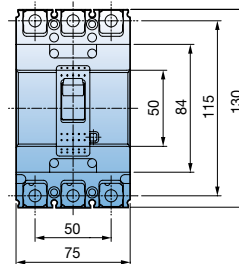

(Fig. 1)



100AF		125AF			250AF			
N-type		S-type	H-type	L-type	N-type	S-type	H-type	L-type
ABN102c	ABN102e	ABS102c	ABH102c	ABL102c	ABN202c	ABS202c	ABH202c	ABL202c
ABN103c	ABN103e	ABS103c	ABH103c	ABL103c	ABN203c	ABS203c	ABH203c	ABL203c
ABN104c	ABN104e	ABS104c	ABH104c	ABL104c	ABN204c	ABS204c	ABH204c	ABL204c
15, 20, 30, 40, 50, 60, 75, 100		15, 20, 30, 40, 50, 60, 75, 100, 125			100, 125, 150, 175, 200, 225, 250			
690	690	690	690	690	690	690	690	690
500	500	500	500	500	500	500	500	500
1000	1000	1000	1000	1000	750	1000	1000	1000
8	8	8	8	8	8	8	8	8
5	7.5 (5)	8	10	10 (10)	8	8	10	10 (10)
10	14 (10)	26	35	35 (35)	18	26	35	35 (35)
18	31 (18)	37	50	60 (50)	26	37	50	60 (50)
22	31 (22)	42	50	60 (50)	30	42	50	60 (50)
35	65 (35)	85	100	125 (100)	65	85	100	125 (100)
10	15 (10)	20	30	30 (30)	10	20	30	30 (30)
10	15 (10)	20	30	30 (30)	10	20	30	30 (30)
100	()	100	100	()	100	100	100	()
75 × 130 × 60mm (Fig. 1)		90 × 155 × 60mm (Fig. 2)			105 × 165 × 60mm (Fig. 3)			

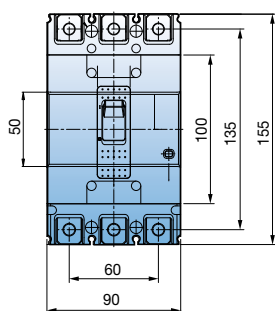

(Fig. 2)

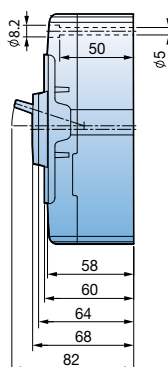

(Fig. 3)

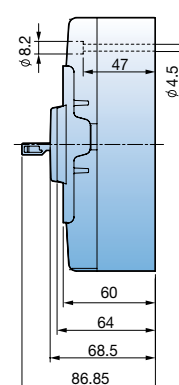
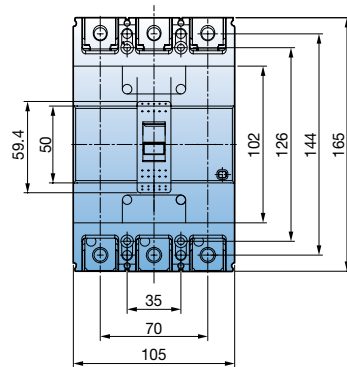

Quick selection table

Molded Case Circuit Breakers



MCCBs

AF		400AF			
Type		N-type	S-type	H-type	L-type
Type and pole	2-pole	ABN402c	ABS402c	ABH402c	ABL402c
	3-pole	ABN403c	ABS403c	ABH403c	ABL403c
	4-pole	ABN404c	ABS404c	ABH404c	ABL404c
Rated current, I _n	A	250, 300, 350, 400			
Rated operational voltage, U _e	AC (V)	690	690	690	690
	DC (V)	500	500	500	500
Rated insulation voltage, U _i	V	1000	1000	1000	1000
Rated impulse withstand voltage, U _{imp}	kV	8	8	8	8

Rated short-circuit breaking capacity (I_{cu}) kA (Sym) , IEC 60947-2

AC	690V	5	8	10	14
	480/500V	18	35	50	65
	415/460V	37	50	65	85
	380V	42	65	70	100
	220/250V	50	75	85	125
DC	500V (3P)	10	20	40	40
	250V (2P)	10	20	40	40
I _{cs} =% × I _{cu}		100	100	100	75
Dimensions (mm)	W×H×D (3-pole)	140×257×109mm (Fig. 4)			

* For more detail see the page. Ratings 5-15page ~ 5-22page, Curves 8-4page ~ 8-5page, and Drawings 9-5page ~ 9-8page

Note) 1.The short-circuit breaking capacities in () are applied to the rated current in (3, 5, 10A) 3.There are certain products for hot areas. (400-800AF on the basis of 50°C)
2.Standard type is designed on the basis of 40°C of ambient temperature.

AF Type	400AF	800AF	1000AF	1200AF
ABN	ABN400c 37kA	ABN800c 37kA		
ABS	ABS400c 50kA	ABS800c 65kA	ABS1000b 65kA	ABS1200b 65kA
ABH	ABH400c 65kA			
ABL	ABL400c 85kA	ABL800c 85kA	ABL1000b 85kA	ABL1200b 85kA

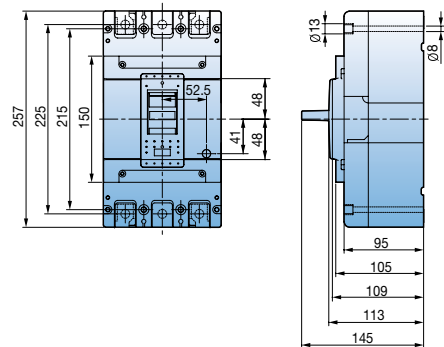

(Fig. 4)



800AF			1000AF		1200AF		
N-type	S-type	L-type	S-type	L-type	S-type		L-type
ABN802c	ABS802c	ABL802c	-	-	-	-	-
ABN803c	ABS803c	ABL803c	ABS1003b	ABL1003b	ABS1203b	ABS1203bE	ABL1203b
ABN804c	ABS804c	ABL804c	ABS1004b	ABL1004b	ABS1204b	-	ABL1204b
500, 630, 700, 800			1000		1200		
690	690	690	600	600	600	600	600
500	500	500	-	-	-	-	-
1000	1000	1000	690	690	690	690	690
8	8	8	6	6	6	6	6
8	10	14	-	-	-	-	-
25	45	65	50	75	50	50	75
37	65	85	65	85	65	65	85
45	75	100	65	85	65	65	85
50	85	125	100	125	100	100	125
10	20	40	-	-	-	-	-
10	20	40	-	-	-	-	-
100	100	75	50	50	50	50	50
210×280×109mm (Fig. 5)			220×400×105mm (Fig. 6)		220×400×105mm (Fig. 6)		

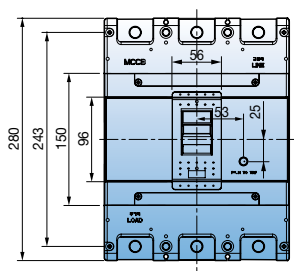

(Fig. 5)

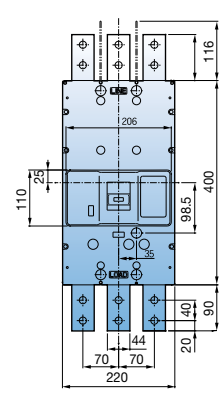
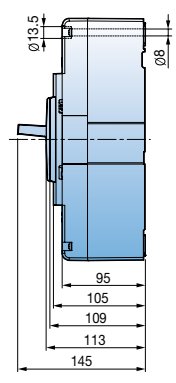

(Fig. 6)

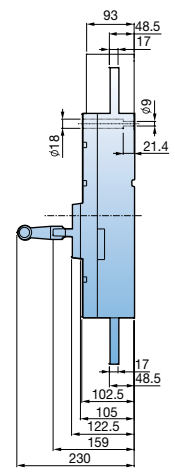

Quick selection table

Motor protection Molded Case Circuit Breakers



MCCBs

AF		30AF		50AF		60AF	
Type		S-type	N-type	S-type	H-type	N-type	S-type
Type and pole	3-pole	ABS33cM	ABN53cM	ABS53cM	ABH53cM	ABN63cM	ABS63cM
Rated current, I _n	A	16, 24	16, 24, 32, 45			60	
Rated operational voltage, U _e	AC (V)	690	690	690	690	690	690
	DC (V)	500	500	500	500	500	500
Rated insulation voltage, U _i	V	750	750	750	750	750	750
Rated impulse withstand voltage, U _{imp}	kV	8	8	8	8	8	8

Rated short-circuit breaking capacity (I_{cu}) kA (Sym) , IEC 60947-2

AC	690V	2.5	2.5	5	10	2.5	5
	480/500V	7.5	7.5	10	35	7.5	10
	415/460V	14	14	18	50	14	18
	380V	18	18	22	50	18	22
	220/250V	30	30	35	100	30	35
DC	500V (3P)	5	5	10	30	5	10
I _{cs} =% × I _{cu}		100	100	100	100	100	100
Dimensions (mm)	W × H × D (3-pole)	75 × 130 × 60mm (Fig. 1)	75 × 130 × 60mm (Fig. 1)		90 × 155 × 60mm (Fig. 2)	75 × 130 × 60mm (Fig. 1)	

* For more detail see the page. Ratings 5-3page - 5-14page, Curves 8-7page - 8-8page, and Drawings 9-2page - 9-4page

Note) 1. Same electrical and physical specification with MCCB.

2. Accessory: same application with MCCB

3. MCCBs can be applied to both 50 and 60Hz.

AF Type	30AF	50AF	60AF	100AF	125AF	250AF
ABN		ABN50cM 14kA	ABN60cM 14kA	ABN100cM 18kA		
ABS	ABS30cM 14kA	ABS50cM 18kA	ABS60cM 18kA		ABS125cM 37kA	ABS250cM 37kA
ABH		ABH50cM 50kA			ABH125cM 50kA	ABH250cM 50kA

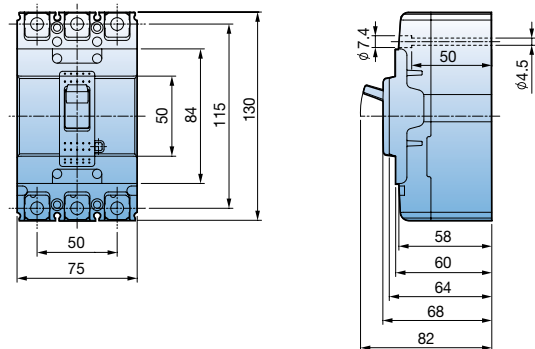

(Fig. 1)



	100AF	125AF		250AF	
	N-type	S-type	H-type	S-type	H-type
	ABN103c	ABS103cM	ABS33cM	ABS203cM	ABH203cM
	60, 75, 90	60, 75, 90		125, 150, 175, 225	
	690	690	690	690	690
	500	500	500	500	500
	750	750	750	750	750
	8	8	8	8	8
	5	8	10	8	10
	10	26	35	26	35
	18	37	50	37	50
	22	42	50	42	50
	35	85	100	85	100
	10	20	30	20	30
	100	100	100	100	100
	75×130×60mm (Fig. 1)	90×155×60mm (Fig. 2)		105×165×60mm (Fig. 3)	

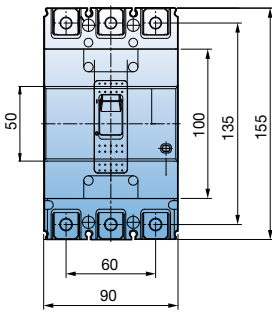

(Fig. 2)

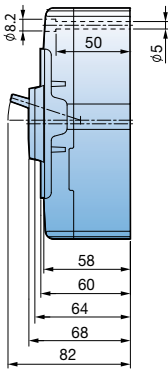

(Fig. 3)

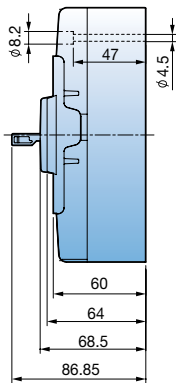
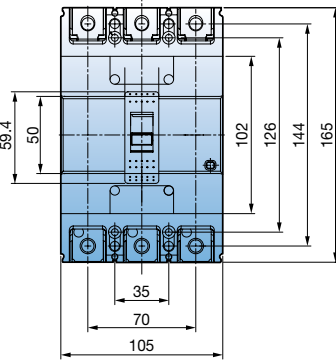

Quick selection table

ZCT Molded Case Circuit Breakers



MCCBs

AF		30AF	50AF			60AF	
Type		S-type	N-type	S-type	H-type	N-type	S-type
Type and pole	2-pole	-	-	-	ABH52cZ	-	-
	3-pole	ABS33cZ	ABN53cZ	ABS53cZ	ABH53cZ	ABN63cZ	ABS63cZ
	4-pole	ABS34cZ	ABN54cZ	ABS54cZ	ABH54cZ	ABN64cZ	ABS64cZ
Rated current, I _n	A	15, 20, 30	15, 20, 30, 40, 50			15, 20, 30, 40, 50, 60	
Rated operational voltage, U _e	AC (V)	690	690	690	690	690	690
Rated insulation voltage, U _i	V	1000	1000	1000	1000	1000	1000
Rated impulse withstand voltage, U _{imp}	kV	8	8	8	8	8	8

Rated short-circuit breaking capacity (I_{cu}) kA (Sym) , IEC 60947-2

AC	690V	2.5	2.5	5	10	2.5	5
	480/500V	7.5	7.5	10	35	7.5	10
	415/460V	14	14	18	50	14	18
	380V	18	18	22	50	18	22
	220/250V	30	30	35	100	30	35
I _{cs} =% × I _{cu}		100	100	100	100	100	100
Dimensions (mm)	W × H × D (3-pole)	75 × 130 × 60mm (Fig. 1)	75 × 130 × 60mm (Fig. 1)		90 × 155 × 60mm (Fig. 2)	75 × 130 × 60mm (Fig. 1)	

* For more detail see the page. Ratings 5-3page ~ 5-14page, Curves 8-1page ~ 8-3page, and Drawings 9-2page ~ 9-4page

Note) 1. Same electrical and physical specification with MCCB.

2. Accessory: Same application with MCCB

3. MCCBs can be applied to both 50 and 60Hz.

4. Marking ZCT on the Aux. cover right side

5. Dimension of ABH52c, ABS102c and ABH102, which have a built-in ZCT, is 60 (W) X 155 (H) X 60 (D) mm

6. 4-pole product's ampacity on neutral conductor is equal to or less than 50% of the rated current.

AF Type	30AF	50AF	60AF	100AF	125AF	250AF
ABN		ABN50cZ 14kA	ABN60cZ 14kA	ABN100cZ 18kA		ABN250cZ 26kA
ABS	ABS30cZ 14kA	ABS50cZ 18kA	ABS60cZ 18kA		ABS125cZ 37kA	ABS250cZ 37kA
ABH		ABH50cZ 50kA			ABH125cZ 50kA	ABH250cZ 50kA

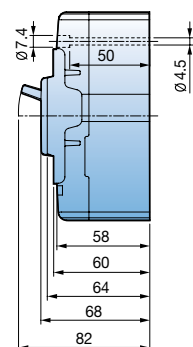
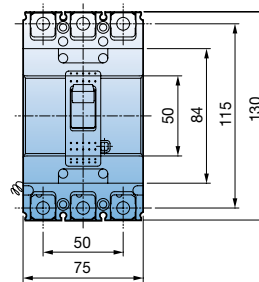

(Fig. 1)



100AF		125AF		250AF		
N-type	S-type	H-type	N-type	S-type	H-type	
-	ABS102cZ	ABH102cZ	-	-	-	
ABN103cZ	ABS103cZ	ABH103cZ	ABN203cZ	ABS203cZ	ABH203cZ	
ABN104cZ	ABS104cZ	ABH104cZ	ABN204cZ	ABS204cZ	ABH204cZ	
15, 20, 30, 40, 50 60, 75, 100	15, 20, 30, 40, 50, 60, 75, 100, 125		100, 125, 150, 175, 200, 225, 250			
690	690	690	690	690	690	
1000	1000	1000	1000	1000	1000	
8	8	8	8	8	8	
5	8	10	8	8	10	
10	26	35	18	26	35	
18	37	50	26	37	50	
22	42	50	30	42	50	
35	85	100	65	85	100	
100	100	100	100	100	100	
75×130×60mm (Fig. 1)	90×155×60mm (Fig. 2)		105×165×60mm (Fig. 3)			

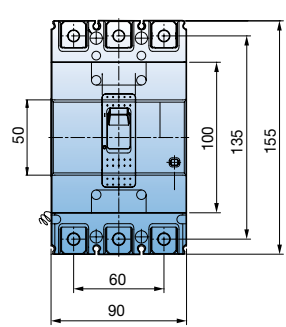

(Fig. 2)

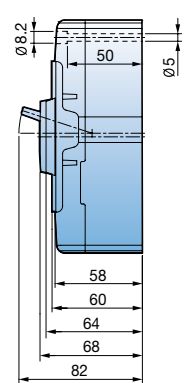

(Fig. 3)

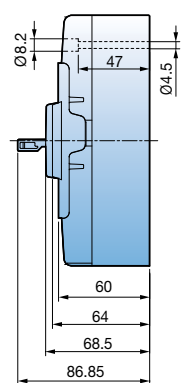
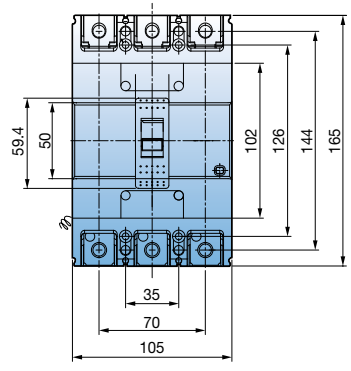

Quick selection table

ZCT Molded Case Circuit Breakers



MCCBs

AF		400AF			
Type		N-type	S-type	H-type	L-type
Type and pole	2-pole	-	-	-	-
	3-pole	ABN403cZ	ABS403cZ	ABH403cZ	ABL403cZ
	4-pole	ABN404cZ	ABS404cZ	ABH404cZ	ABL404cZ
Rated current, I _n	A	250, 300, 350, 400			
Rated operational voltage, U _e	AC (V)	690	690	690	690
Rated insulation voltage, U _i	V	1000	1000	1000	1000
Rated impulse withstand voltage, U _{imp}	kV	8	8	8	8
Rated short-circuit breaking capacity (I_{cu}) kA (Sym) , IEC 60947-2					
AC	690V	5	8	10	14
	480/500V	18	35	50	65
	415/460V	37	50	65	85
	380V	42	65	70	100
	220/250V	50	75	85	125
I _{cs} =% × I _{cu}		100	100	100	75
Dimensions (mm)	W × H × D (3-pole)	140 × 257 × 109mm (Fig. 4)			

- * For more detail see the page. Ratings 5-15page ~ 5-18page, Curves 8-4page and Drawings 9-5page ~ 9-6page
- Note) 1. Same electrical and physical specification with MCCB.
 2. Accessory: Same application with MCCB
 3. MCCBs can be applied to both 50 and 60Hz.
 4. Marking ZCT on the Aux. cover right side
 5. 4-pole product's ampacity on neutral conductor is equal to or less than 50% of the rated current.

Type \ AF	400AF	800AF
ABN	ABN400c 37kA	ABN800c 37kA
ABS	ABS400c 50kA	ABS800c 65kA
ABH	ABH400c 65kA	
ABL	ABL400c 85kA	ABL800c 85kA

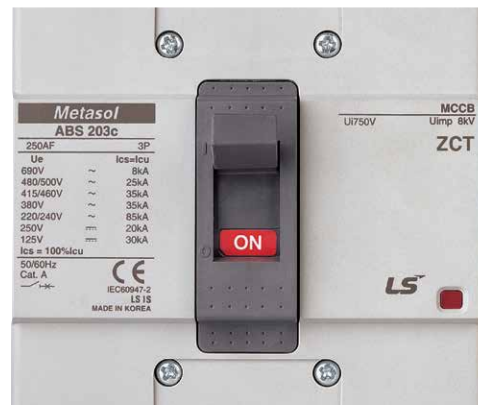



800AF

	N-type	S-type	L-type
	-	-	-
	ABN803cZ	ABS803cZ	ABL803cZ
	-	-	-
	500, 630, 700, 800		
	690	690	690
	1000	1000	1000
	8	8	8
	8	10	14
	25	45	65
	37	65	85
	45	75	100
	50	85	125
	100	100	75
	210×280×109mm (Fig. 5)		

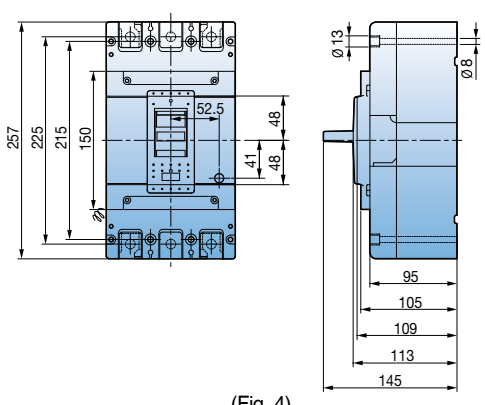

(Fig. 4)

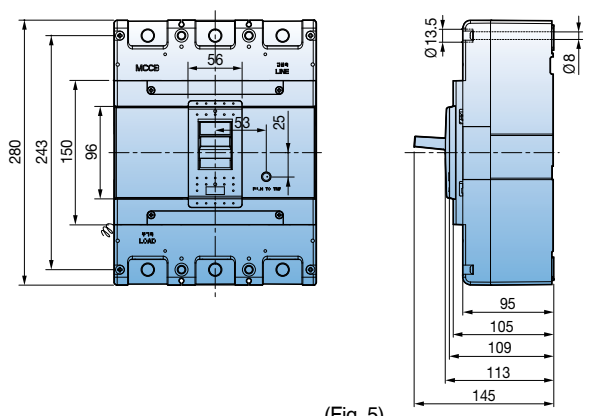

(Fig. 5)

Quick selection table

Earth Leakage Circuit Breakers



ELCBs

AF		30AF	50AF			60AF	
Type		S-type	N-type	S-type	H-type	N-type	S-type
Type and pole	2-pole	EBS32c	EBN52c	-	-	-	-
	3-pole	EBS33c	EBN53c	EBS53c	EBH53c	EBN63c	EBS63c
	4-pole	EBS34c	-	EBS54c	EBH54c	-	EBS64c
Protective function		Overload, short-circuit and ground fault	Overload, short-circuit and ground fault			Overload, short-circuit and ground fault	
Rated current, I _n	A	(5, 10) ^{Note 1} , 15, 20, 30	15, 20, 30, 40, 50			60	
Rated impulse withstand voltage, U _{imp}	kV	6	6			6	
Instantaneous type	Rated residual current, I _{Δn}	mA	30, 100, 100/200/500, 100/300/500mA			30, 100, 100/200/500, 100/300/500mA	
	Residual current off-time at I _{Δn}	sec	≤ 0.1 sec			≤ 0.1 sec	
	Rated operational voltage, U _e	AC (V)	220/460			220/460	
Time delay type	Rated residual current	1A	0.1/0.2/0.5/1			0.1/0.2/0.5/1	
	Intentional time delay	1s	0/0.2/0.5/1			0/0.2/0.5/1	
	Rated residual current	2A	0.1/0.4/1/2			0.1/0.4/1/2	
	Intentional time delay	2s	0.5/1/1.5/2			0.5/1/1.5/2	

Rated short-circuit breaking capacity (I_{cu}) kA (Sym) , IEC 60947-2

AC	415/460V	14 (10)	14	18	50	14	18
	220/250V	30 (25)	30	35	100	30	35
I _{cs} =% × I _{cu}		100	100	100	100	100	100
Dimensions (mm)	W×H×D	75×130×60mm	75×130×60mm		90×155×60mm	75×130×60mm	
	(3-pole)	(Fig. 1)	(Fig. 1)		(Fig. 2)	(Fig. 1)	

* For more detail see the page. Ratings 6-1page ~ 6-12page, Curves 8-1 ~ 8-3page and Drawings 9-9page ~ 9-11page

Note) 1. MCCBs can be applied to both 50 and 60Hz.

2. Do not test withstand voltage or insulation resistance test between poles to avoid the damage of the PCB.

3. The short-circuit breaking capacities in () are applied to the rated current in (5, 10A)

4. Below 250AF Some ELCBs have a test lead type for remote testing.

AF Type	30AF	50AF	60AF	100AF	125AF	250AF
EBS	EBS30c 14kA	EBS50c 18kA	EBS60c 18kA		EBS125c 37kA	EBS250c 37kA
EBN		EBN50c 14kA	EBN60c 14kA	EBN100c 18kA		EBN250c 26kA
EBH		EBH50c 50kA			EBH125c 50kA	EBH250c 50kA

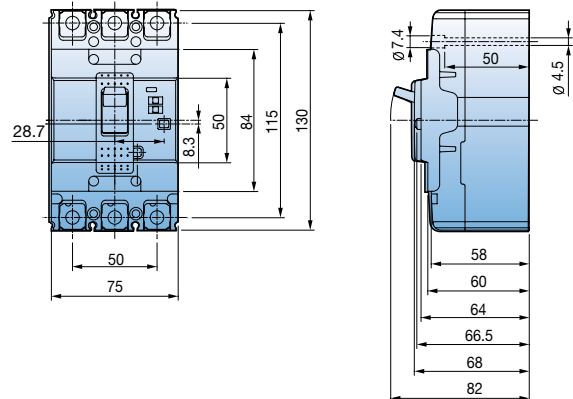

(Fig. 1)



100AF		125AF		250AF		
N-type	S-type	H-type	N-type	S-type	H-type	
EBN102c	-	-	EBN202c	-	-	
EBN103c	EBS103c	EBH103c	EBN203c	EBS203c	EBH203c	
EBN104c	EBS104c	EBH104c	-	EBS204c	EBH204c	
Overload, short-circuit and ground fault	Overload, short-circuit and ground fault		Overload, short-circuit and ground fault			
60, 75, 100	15, 20, 30, 40, 50, 60, 75, 100, 125		100, 125, 150, 175, 200, 225, 250			
6	6		6			
30, 100, 100/200/500, 100/300/500mA	30, 100, 100/200/500, 100/300/500mA		30, 100, 100/200/500, 100/300/500mA			
≤0.1 sec	≤0.1 sec		≤0.1 sec			
220/460	220/460		220/460			
0.1/0.2/0.5/1	0.1/0.2/0.5/1		0.1/0.2/0.5/1			
0/0.2/0.5/1	0/0.2/0.5/1		0/0.2/0.5/1			
0.1/0.4/1/2	0.1/0.4/1/2		0.1/0.4/1/2			
0.5/1/1.5/2	0.5/1/1.5/2		0.5/1/1.5/2			
18	37	50	26	37	50	
35	85	100	65	85	100	
100	100	100	100	100	100	
75 × 130 × 60mm (Fig. 1)	90 × 155 × 60mm (Fig. 2)		105 × 165 × 60mm (Fig. 3)			

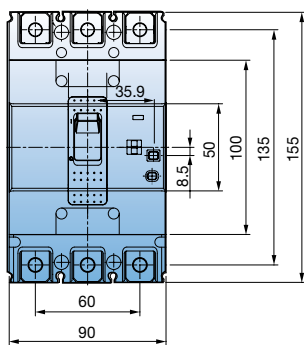

(Fig. 2)

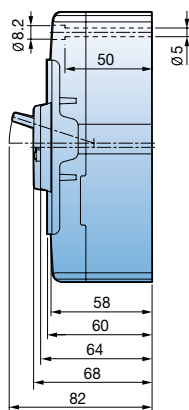

(Fig. 3)

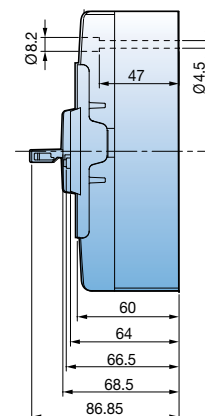
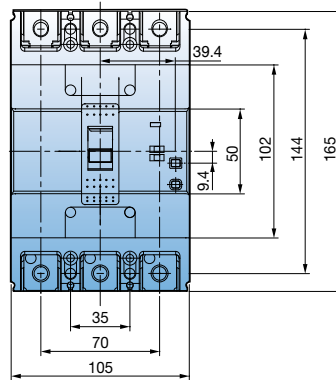

Quick selection table

Earth Leakage Circuit Breakers



ELCBs

AF		400AF			
Type		N-type	S-type	H-type	L-type
	3-pole	EBN403c	EBS403c	EBH403c	EBL403c
	4-pole	EBN404c	EBS404c	EBH404c	EBL404c
Protective function		Overload, short-circuit and ground fault			
Rated current, I _n	A	250, 300, 350, 400			
Rated residual current, I _{Δn}	mA	30, 100/200/500mA			
Rated operational voltage, U _e	AC (V)	220/460	220/460	220/460	220/460
Rated impulse withstand voltage, U _{imp}	kV	6	6	6	6
Residual current off-time at I _{Δn}	sec	≤0.1 sec	≤0.1 sec	≤0.1 sec	≤0.1 sec
Rated short-circuit breaking capacity (I_{cu}) kA (Sym) , IEC 60947-2					
AC	415/460V	37	50	65	85
	220/250V	50	75	85	125
	I _{cs} =% × I _{cu}	100	100	100	75
Dimensions (mm)	W × H × D (3-pole)	140 × 257 × 109mm (Fig. 4)			

* For more detail see the page. Ratings 6-13page ~ 6-18page, Curves 8-4~ 8-5page and Drawings 9-12page ~ 9-14page
 Note) 1. MCCBs other than 1,000/1200AF can be applied to both 50 and 60Hz.
 2. Do not test withstand voltage or insulation resistance test between poles to avoid the damage of the PCB.

Type	AF	400AF	800AF	1000AF	1200AF
EBN		EBN400c 37kA	EBN800c 37kA		
EBS		EBS400c 50kA	EBS800c 65kA	EBS1000b 65kA	EBS1200b 65kA
EBH		EBH400c 65kA			
EBL		EBL400c 85kA	EBL800c 85kA		

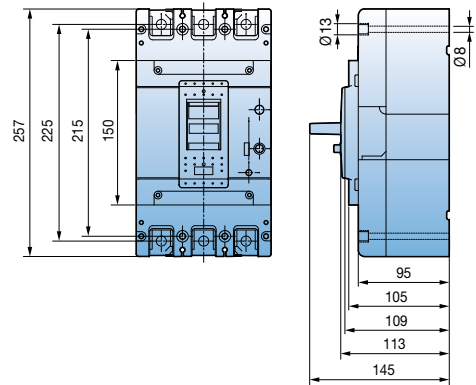

(Fig. 4)



	800AF			1000AF	1200AF
	N-type	S-type	L-type	S-type	S-type
	EBN803c	EBS803c	EBL803c	EBN1003b	EBS1203b
	-	-	-	-	-
	Overload, short-circuit and ground fault			Overload, short-circuit and ground fault	
	500, 630, 700, 800			1000	1200
	30, 100/200/500mA			100/200/500mA	100/200/500mA
	220/460	220/460	220/460	220/460	220/460
	6	6	6	-	-
	≤0.1 sec	≤0.1 sec	≤0.1 sec	≤0.1 sec	≤0.1 sec
	37	65	85	85	85
	50	85	125	125	125
	100	100	75	-	-
	210×280×109mm (Fig. 5)			220 × 565 × 105mm (Fig. 6)	

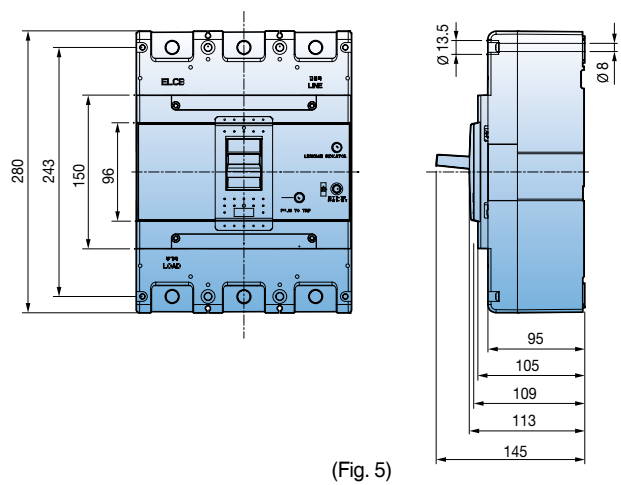

(Fig. 5)

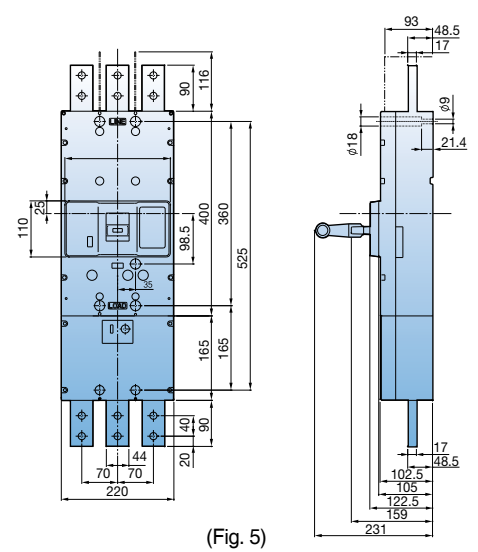

(Fig. 6)

Type numbering system

MCCB

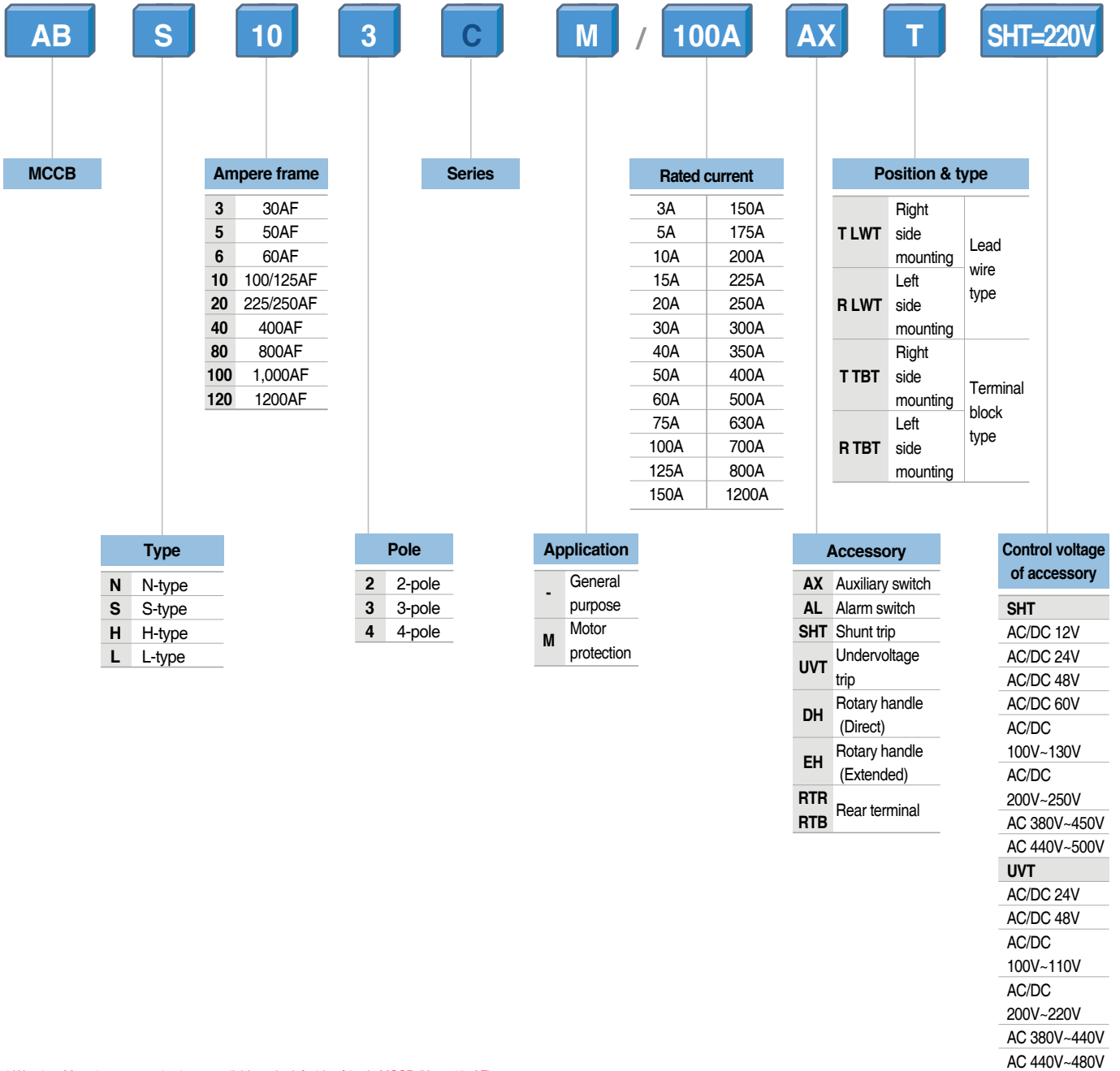

* Warning: Mounting accessories is not available at the left side of 2pole MCCB (Up to 125AF)

ELCB

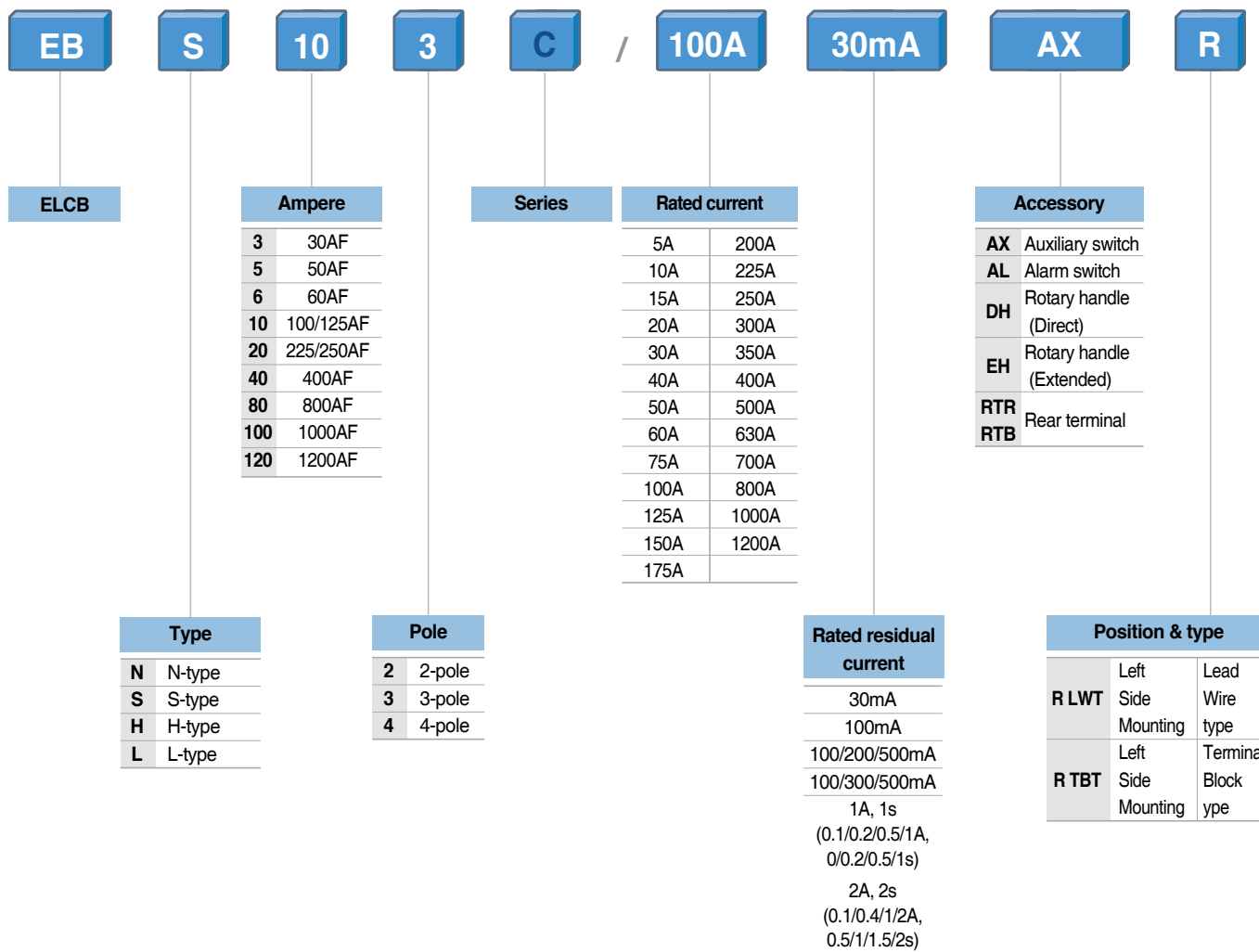

* Warning: Mounting accessories is not available at the right side ELCB (Up to 250AF)

30AF MCCB

ABE30b



ABE32b



ABE33b

Ratings

Frame size		30AF		
Type and pole		E-type		
	2-pole	ABE32b		
	3-pole	ABE33b		
	4-pole	-		
Rated current, I _n		3-5-10-15-20-30A		
Rated operational voltage, U _e		AC: 460V		
		-		
Rated insulation voltage, U _i		AC: 460V		
Rated impulse withstand voltage, U _{imp}		6kV		
Rated short-circuit breaking capacity, I_{cu}		E-type		
AC	690V	-		
IEC 60947-2 (I _{cu})	480/500V	-		
	460V	2.5kA		
	415V	2.5kA		
	380V	2.5kA		
	220/250V	5kA		
DC	500V (3P)	-		
	250V (2P)	-		
I _{cs} =%×I _{cu}		50%		
Protective function		Overload, short-circuit		
Type of trip unit		Hydraulic-magnetic		
Magnetic trip range		12I _n		
Endurance	Mechanical	8,500 operations		
	Electrical	1,500 operations		
Connection	Standard	Front connection		
	Optional	-		
Mounting		Screw fixing		
Dimensions (mm)		Pole	2p	3p
		a	50	75
		b	96	96
		c1 <small>Note)</small>	60	60
		c2 <small>Note)</small>	-	-
		d	80	80
		Weight, kg	Standard	0.5
Certification		Pole	2p	3p
CE marking		☐	○	○

Note) Depth by door cut size: c1 for large cut, c2 for small cut

For more information

- Accessories ▶ 7-1 page
- Trip curves ▶ 8-1 page
- Drawings ▶ 9-1 page
- Connection and mounting ▶ 10-2 page

Ordering types

Breaker types

ABE type (2.5kA/460V)		
Rated current, In	2-pole	3-pole
3 A	ABE32b/3	ABE33b/3
5 A	ABE32b/5	ABE33b/5
10 A	ABE32b/10	ABE33b/10
15 A	ABE32b/15	ABE33b/15
20 A	ABE32b/20	ABE33b/20
30 A	ABE32b/30	ABE33b/30

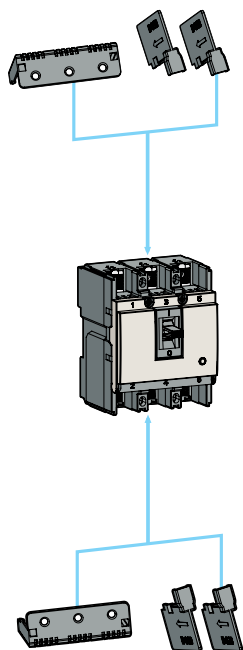

Accessories

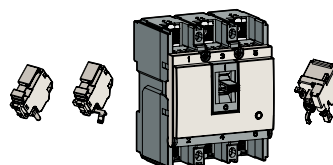

Electrical auxiliaries

AX	Auxiliary switch
AL	Alarm switch
SHT	Shunt trip



Maximum possibilities

T-position	One of above auxiliaries
R-position	Option of AX or AL

Note) For more detail see 7-1 page

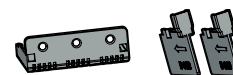

External accessories

ABE30b	Name
B-03B	Insulation barrier
TBS23	Short type

Note) For more detail see 7-9 ~ 7-26 page

30AF MCCB

ABS30c



ABS32c



ABS33c



ABS34c

Ratings

Frame size		30AF			
Type and pole		E-type			
2-pole		ABS32c			
3-pole		ABS33c			
4-pole		ABS34c			
Rated current, I _n		(3-5-10) ^{Note1} -15-20-30A			
Rated operational voltage, U _e		AC: 690V			
		DC: 500V			
Rated insulation voltage, U _i		AC: 1000V			
Rated impulse withstand voltage, U _{imp}		8kV			
Rated short-circuit breaking capacity, I_{cu}		S-type			
AC	IEC 60947-2 (I _{cu})	690V	2.5kA		
		480/500V	7.5 (5)kA		
		460V	14 (10)kA		
		415V	14 (10)kA		
		380V	18 (14)kA		
		220/250V	30 (25)kA		
DC		500V (3P)	5kA		
		250V (2P)	5kA		
I _{cs} =%×I _{cu}		100%			
Protective function		Overload, short-circuit			
Type of trip unit		Thermal-magnetic			
Magnetic trip range		400A			
Endurance	Mechanical	25,000 operations			
	Electrical	10,000 operations			
Connection	Standard	Front connection			
	Optional	Rear connection			
		Plug-in			
Mounting	Standard	Screw fixing			
Dimensions (mm)		Pole	2p	3p	4p
		a	50	75	100
		b	130	130	130
		c1 ^{Note2}	60	60	60
		c2 ^{Note2}	64	64	64
		d	82	82	82
		Weight, kg	Standard	0.5	0.7
Certification		Pole	2p	3p	4p
CE marking		CE	○	○	○

Note 1. The short-circuit breaking capacities in () are applied to the rated current in (3, 5, 10A)

2. Depth by door cut size: c1 for large cut, c2 for small cut

3. 4-pole product's ampacity on neutral conductor is equal to or less than 50% of the rated current.

For more information

- Accessories ▶ 7-1 page
- Trip curves ▶ 8-1 page
- Drawings ▶ 9-2 page
- Connection and mounting ▶ 10-2 page

Ordering types

Breaker types

ABS type (10kA/460V)			
Rated current, In	2-pole	3-pole	4-pole
3 A	ABS32c/3	ABS33c/3	ABS34c/3
5 A	ABS32c/5	ABS33c/5	ABS34c/5
10 A	ABS32c/10	ABS33c/10	ABS34c/10

ABS type (14kA/460V)			
Rated current, In	2-pole	3-pole	4-pole
15 A	ABS32c/15	ABS33c/15	ABS34c/15
20 A	ABS32c/20	ABS33c/20	ABS34c/20
30 A	ABS32c/30	ABS33c/30	ABS34c/30

Accessories

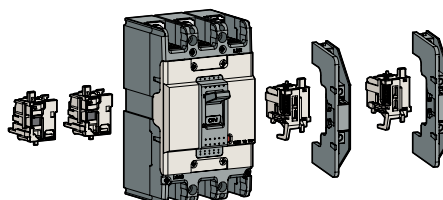

Electrical auxiliaries

AX	Auxiliary switch	
AL	Alarm switch	
AX+AL	Combination switch	
SHT	Shunt trip	
UVT	Undervoltage trip	

Maximum possibilities

T-position	One of above auxiliaries
R-position	Option of AX or AL or AX+AL

Note) For more detail see 7-1 page

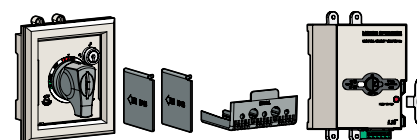
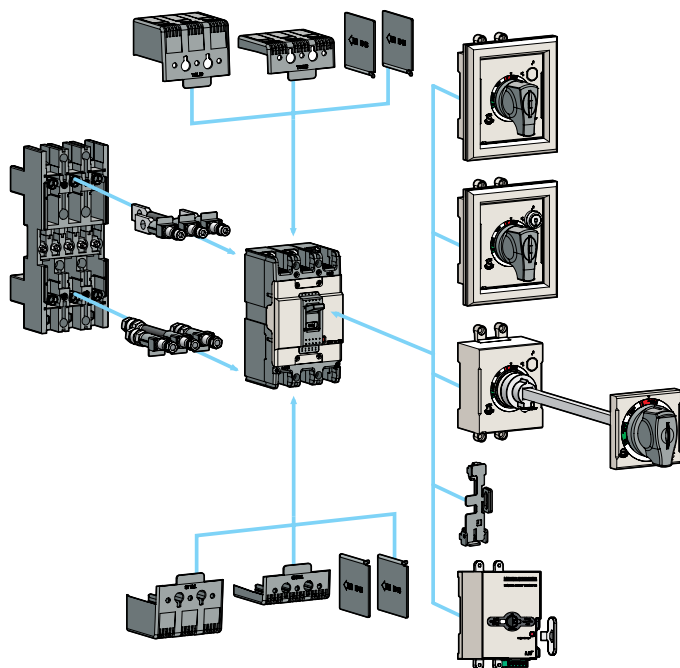

External accessories

ABS30c	Name
IB13	Insulation barrier
TCL13	Terminal cover (Long) - Inde type, D-handle type, N-handle type
TCS13	Terminal cover (Short) - Inde type, D-handle type, N-handle type
DH100	Rotary handle (Direct)
DHK100	Rotary handle (Direct, key lock)
EH100	Rotary handle (Extended)
RTR1	Rear terminal (Round)
PB-A3	Plug-in kit
Handle lock	
MOP-M1	Remote operation

Note) For more detail see 7-9 ~ 7-26 page

- Inde type: This cover is used without auxiliary handle.
- D-handle type: This cover is used with D-handle.
- N-handle type: This cover is used with N-handle.

50AF MCCB

ABN50c, ABS50c, ABH50c



ABS52c



ABS53c



ABS54c

Ratings

Frame size		50AF									
Type and pole		N-type			S-type			H-type			
	2-pole	ABN52c			ABS52c			ABH52c			
	3-pole	ABN53c			ABS53c			ABH53c			
	4-pole	ABN54c			ABS54c			ABH54c			
Rated current, I _n		15-20-30-40-50A									
Rated operational voltage, U _e		AC: 690V									
		DC: 500V									
Rated insulation voltage, U _i		AC: 1000V									
Rated impulse withstand voltage, U _{imp}		8kV									
Rated short-circuit breaking capacity, I_{cu}		N-type			S-type			H-type			
AC	IEC 60947-2 (I _{cu})	690V	2.5kA	5kA	10kA						
		480/500V	7.5kA	10kA	35kA						
		460V	14kA	18kA	50kA						
		415V	14kA	18kA	50kA						
		380V	18kA	22kA	50kA						
		220/250V	30kA	35kA	100kA						
	DC	500V (3P)	5kA	10kA	30kA						
	250V (2P)	5kA	10kA	30kA							
I _{cs} =%×I _{cu}		100%			100%			100%			
Protective function		Overload, short-circuit									
Type of trip unit		Thermal-magnetic									
Magnetic trip range		12×I _n (30A and under: 400A)									
Endurance	Mechanical	25,000 operations									
	Electrical	10,000 operations									
Connection	Standard	Front connection									
	Optional	Rear connection									
Mounting		Plug-in									
Standard		Screw fixing									
Dimensions (mm)		Pole	2p	3p	4p	2p	3p	4p	2p	3p	4p
		a	50	75	100	50	75	100	60	90	120
		b	130			130			155		
		c1 <i>Note1</i>	60			60			60		
		c2 <i>Note1</i>	64			64			64		
		d	82			82			82		
Weight, kg		Standard	0.5	0.7	0.9	0.5	0.7	0.9	0.7	1	1.2
Certification		Pole	2p	3p	4p	2p	3p	4p	2p	3p	4p
CE marking		CE	○			○			○		

Note) 1. Depth by door cut size: c1 for large cut, c2 for small cut
 2. 4-pole product's ampacity on neutral conductor is equal to or less than 50% of the rated current.

For more information

- Accessories ▶ 7-1 page
- Trip curves ▶ 8-1 page
- Drawings ▶ 9-2 page
- Connection and mounting ▶ 10-2 page

Ordering types

Breaker types

ABN type (14kA/460V)			
Rated current, In	2-pole	3-pole	4-pole
15 A	ABN52c/15	ABN53c/15	ABN54c/15
20 A	ABN52c/20	ABN53c/20	ABN54c/20
30 A	ABN52c/30	ABN53c/30	ABN54c/30
40 A	ABN52c/40	ABN53c/40	ABN54c/40
50 A	ABN52c/50	ABN53c/50	ABN54c/50

ABS type (18kA/460V)			
Rated current, In	2-pole	3-pole	4-pole
15 A	ABS52c/15	ABS53c/15	ABS54c/15
20 A	ABS52c/20	ABS53c/20	ABS54c/20
30 A	ABS52c/30	ABS53c/30	ABS54c/30
40 A	ABS52c/40	ABS53c/40	ABS54c/40
50 A	ABS52c/50	ABS53c/50	ABS54c/50

ABH type (50kA/460V)			
Rated current, In	2-pole	3-pole	4-pole
15 A	ABH52c/15	ABH53c/15	ABH54c/15
20 A	ABH52c/20	ABH53c/20	ABH54c/20
30 A	ABH52c/30	ABH53c/30	ABH54c/30
40 A	ABH52c/40	ABH53c/40	ABH54c/40
50 A	ABH52c/50	ABH53c/50	ABH54c/50

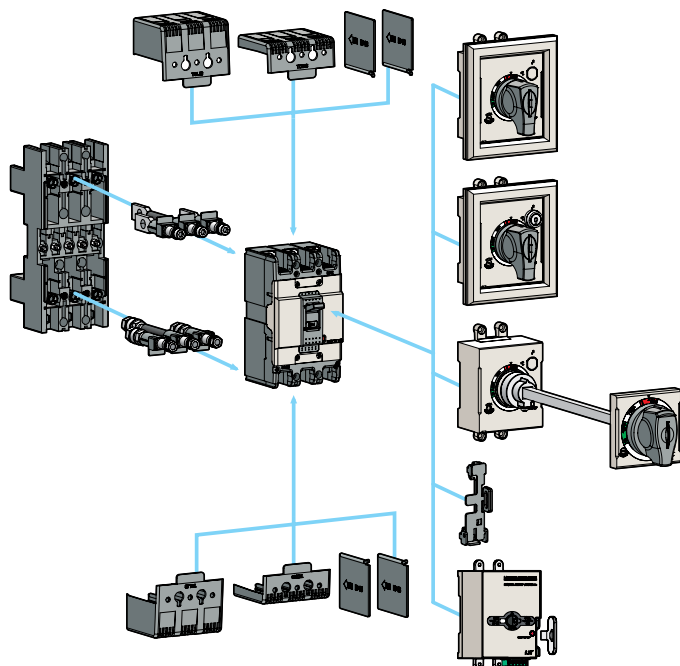

Accessories

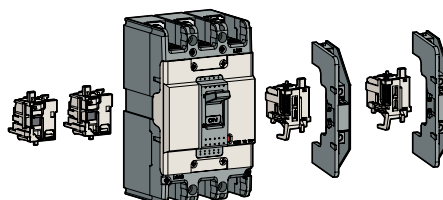

Electrical auxiliaries

AX	Auxiliary switch	
AL	Alarm switch	
AX+AL	Combination switch	
SHT	Shunt trip	
UVT	Undervoltage trip	

Maximum possibilities

T-position	One of above auxiliaries
R-position	Option of AX or AL or AX+AL

Note) For more detail see 7-1 page

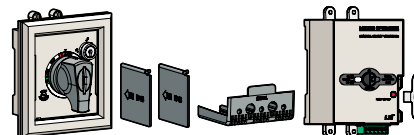

External accessories

ABN50c ABS50c	ABH50c	Name
IB13	IB23	Insulation barrier
TCL13	TCL23	Terminal cover (Long) - Inde type, D-handle type, N-handle type
TCS13	TCS23	Terminal cover (Short) - Inde type, D-handle type, N-handle type
DH100	DH125	Rotary handle (Direct)
DHK100	DHK125	Rotary handle (Direct, key lock)
EH100	EH125	Rotary handle (Extended)
-	RTB2	Rear terminal (Bar)
RTR1	RTR2	Rear terminal (Round)
PB-A3	PB-C3	Plug-in kit
Handle lock		
MOP-M1	MOP-M2	Remote operation

Note) For more detail see 7-9 ~ 7-26 page

- Inde type: This cover is used without auxiliary handle.
- D-handle type: This cover is used with D-handle.
- N-handle type: This cover is used with N-handle.

60AF MCCB

ABN60c, ABS60c



ABS62c



ABS63c



ABS64c

Ratings

Frame size		60AF						
Type and pole		N-type			S-type			
	2-pole	ABN62c			ABS62c			
	3-pole	ABN63c			ABS63c			
	4-pole	ABN64c			ABS64c			
Rated current, I _n		15-20-30-40-50-60A						
Rated operational voltage, U _e		AC: 690V						
		DC: 500V						
Rated insulation voltage, U _i		AC: 1000V						
Rated impulse withstand voltage, U _{imp}		8kV						
Rated short-circuit breaking capacity, I_{cu}		N-type			S-type			
	AC 690V	2.5kA			5kA			
	IEC 60947-2 (I _{cu})	480/500V			10kA			
	460V	14kA			18kA			
	415V	14kA			18kA			
	380V	18kA			22kA			
	220/250V	30kA			35kA			
	DC 500V (3P)	5kA			10kA			
	250V (2P)	5kA			10kA			
I _{cs} =%×I _{cu}		100%			100%			
Protective function		Overload, short-circuit						
Type of trip unit		Thermal-magnetic						
Magnetic trip range		12×I _n (30A and under: 400A)						
Endurance	Mechanical	25,000 operations						
	Electrical	10,000 operations						
Connection	Standard	Front connection						
	Optional	Rear connection						
Mounting		Plug-in						
Standard		Screw fixing						
Dimensions (mm)		Pole	2p	3p	4p	2p	3p	4p
		a	50	75	100	50	75	100
		b	130			130		
		c1 <i>Note1</i>	60			60		
		c2 <i>Note1</i>	64			64		
		d	82			82		
Weight, kg		Standard	0.5	0.7	0.9	0.5	0.7	0.9
Certification		Pole	2p			3p		
CE marking		☐	○			○		

Note) 1. Depth by door cut size: c1 for large cut, c2 for small cut
 2. 4-pole product's ampacity on neutral conductor is equal to or less than 50% of the rated current.

For more information

- Accessories ▶ 7-1 page
- Trip curves ▶ 8-1 page
- Drawings ▶ 9-2 page
- Connection and mounting ▶ 10-2 page

Ordering types

Breaker types

ABN type (14kA/460V)			
Rated current, In	2-pole	3-pole	4-pole
15 A	ABN62c/15	ABN63c/15	ABN64c/15
20 A	ABN62c/20	ABN63c/20	ABN64c/20
30 A	ABN62c/30	ABN63c/30	ABN64c/30
40 A	ABN62c/40	ABN63c/40	ABN64c/40
50 A	ABN62c/50	ABN63c/50	ABN64c/50
60 A	ABN62c/60	ABN63c/60	ABN64c/60

ABS type (18kA/460V)			
Rated current, In	2-pole	3-pole	4-pole
15 A	ABS62c/15	ABS63c/15	ABS64c/15
20 A	ABS62c/20	ABS63c/20	ABS64c/20
30 A	ABS62c/30	ABS63c/30	ABS64c/30
40 A	ABS62c/40	ABS63c/40	ABS64c/40
50 A	ABS62c/50	ABS63c/50	ABS64c/50
60 A	ABS62c/60	ABS63c/60	ABS64c/60

Accessories

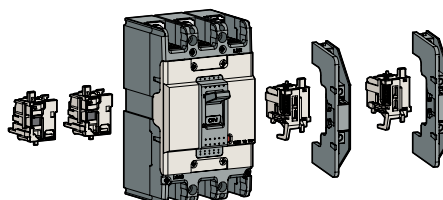

Electrical auxiliaries

AX	Auxiliary switch	
AL	Alarm switch	
AX+AL	Combination switch	
SHT	Shunt trip	
UVT	Undervoltage trip	

Maximum possibilities

T-position	One of above auxiliaries
R-position	Option of AX or AL or AX+AL

Note) For more detail see 7-1 page

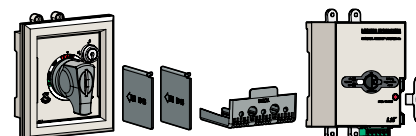
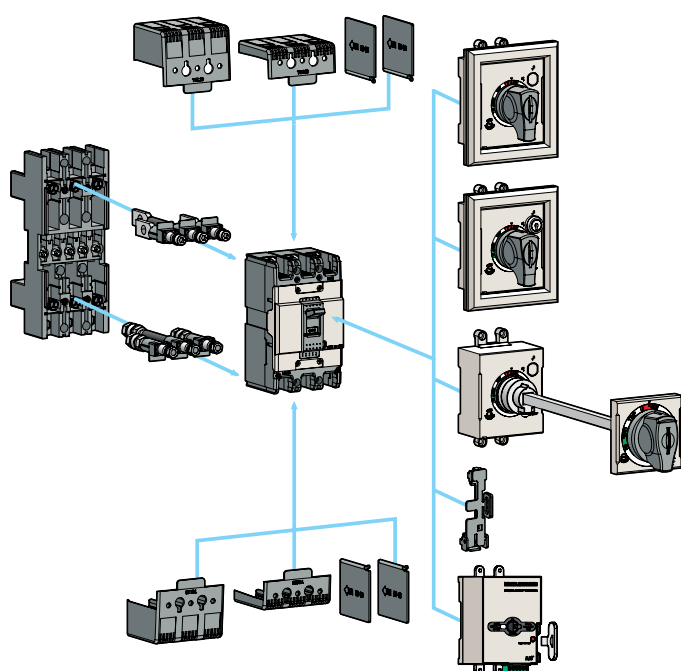

External accessories

ABN50c ABS50c	Name
IB13	Insulation barrier
TCL13	Terminal cover (Long) - Inde type, D-handle type, N-handle type
TCS13	Terminal cover (Short) - Inde type, D-handle type, N-handle type
DH100	Rotary handle (Direct)
DHK100	Rotary handle (Direct, key lock)
EH100	Rotary handle (Extended)
RTB1	Rear terminal (Bar)
RTR1	Rear terminal (Round)
PB-A3	Plug-in kit
handle lock	
MOP-M1	Remote operation

Note) For more detail see 7-9 ~ 7-26 page

- Inde type: This cover is used without auxiliary handle.
- D-handle type: This cover is used with D-handle.
- N-handle type: This cover is used with N-handle.

100AF MCCB

ABN100c, ABN100e



ABN102c



ABN103c



ABN104c

For more information

- Accessories ▶ 7-1 page
- Trip curves ▶ 8-1 page
- Drawings ▶ 9-2 page
- Connection and mounting ▶ 10-2 page

Ratings

Frame size		100AF			
Type and pole		N-type			
	2-pole	ABN102c		ABN102e	
	3-pole	ABN103c		ABN103e	
	4-pole	ABN104c		ABN104e	
Rated current, I _n		15-20-30-40-50-60-75-100A			
Rated operational voltage, U _e		AC: 690V			
		DC: 500V			
Rated insulation voltage, U _i		AC: 1000V			
Rated impulse withstand voltage, U _{imp}		8kV			
Rated short-circuit breaking capacity, I_{cu}		N-type			
	AC	690V	5kA	7.5 (5)kA	
	IEC 60947-2 (I _{cu})	480/500V	10kA	14 (10)kA	
		460V	18kA	31 (18)kA	
		415V	18kA	31 (18)kA	
		380V	22kA	31 (22)kA	
		220/250V	35kA	65 (35)kA	
	DC	500V (3P)	10kA	15 (10)kA	
		250V (2P)	10kA	15 (10)kA	
I _{cs} =%×I _{cu}		100%		()	
Protective function		Overload, short-circuit			
Type of trip unit		Thermal-magnetic			
Magnetic trip range		400A			
Endurance	Mechanical	25,000 operations			
	Electrical	10,000 operations			
Connection	Standard	Front connection			
	Optional	Rear connection			
		Plug-in			
Mounting	Standard	Screw fixing			
Dimensions (mm)		Pole	2p	3p	4p
		a	50	75	100
		b	130	130	130
		c1 <small>Note1</small>	60	60	60
		c2 <small>Note1</small>	64	64	64
		d	82	82	82
		Weight, kg	Standard	0.5	0.7
Certification		Pole	2p	3p	4p
CE marking		CE	○	○	○

Note) 1. Depth by door cut size: c1 for large cut, c2 for small cut
 2. 4-pole product's ampacity on neutral conductor is equal to or less than 50% of the rated current.
 3. The I_{cs}(Service breaking capacity) of ABN100e are in ()

Ordering types

Breaker types

ABN-c type (18kA/460V)			
Rated current, In	2-pole	3-pole	4-pole
15 A	ABN102c/15	ABN103c/15	ABN104c/15
20 A	ABN102c/20	ABN103c/20	ABN104c/20
30 A	ABN102c/30	ABN103c/30	ABN104c/30
40 A	ABN102c/40	ABN103c/40	ABN104c/40
50 A	ABN102c/50	ABN103c/50	ABN104c/50
60 A	ABN102c/60	ABN103c/60	ABN104c/60
75 A	ABN102c/75	ABN103c/75	ABN104c/75
100 A	ABN102c/100	ABN103c/100	ABN104c/100

ABN-e type (31kA/460V)			
Rated current, In	2-pole	3-pole	4-pole
15 A	ABN102e/15	ABN103e/15	ABN104e/15
20 A	ABN102e/20	ABN103e/20	ABN104e/20
30 A	ABN102e/30	ABN103e/30	ABN104e/30
40 A	ABN102e/40	ABN103e/40	ABN104e/40
50 A	ABN102e/50	ABN103e/50	ABN104e/50
60 A	ABN102e/60	ABN103e/60	ABN104e/60
75 A	ABN102e/75	ABN103e/75	ABN104e/75
100 A	ABN102e/100	ABN103e/100	ABN104e/100

Accessories

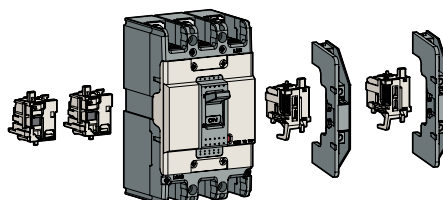

Electrical auxiliaries

AX	Auxiliary switch	
AL	Alarm switch	
AX+AL	Combination switch	
SHT	Shunt trip	
UVT	Undervoltage trip	

Maximum possibilities

T-position	One of above auxiliaries
R-position	Option of AX or AL or AX+AL

Note) For more detail see 7-1 page

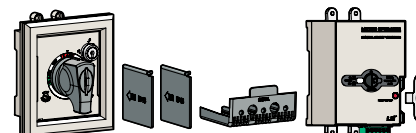

External accessories

ABN100c	Name
IB13	Insulation barrier
TCL13	Terminal cover (Long) - Inde type, D-handle type, N-handle type
TCS13	Terminal cover (Short) - Inde type, D-handle type, N-handle type
DH100	Rotary handle (Direct)
DHK100	Rotary handle (Direct, key lock)
EH100	Rotary handle (Extended)
RTB1	Rear terminal (Bar)
RTR1	Rear terminal (Round)
PB-A3	Plug-in kit
Handle lock	
MOP-M1	Remote operation

Note) For more detail see 7-9 ~ 7-26 page

- Inde type: This cover is used without auxiliary handle.
- D-handle type: This cover is used with D-handle.
- N-handle type: This cover is used with N-handle.

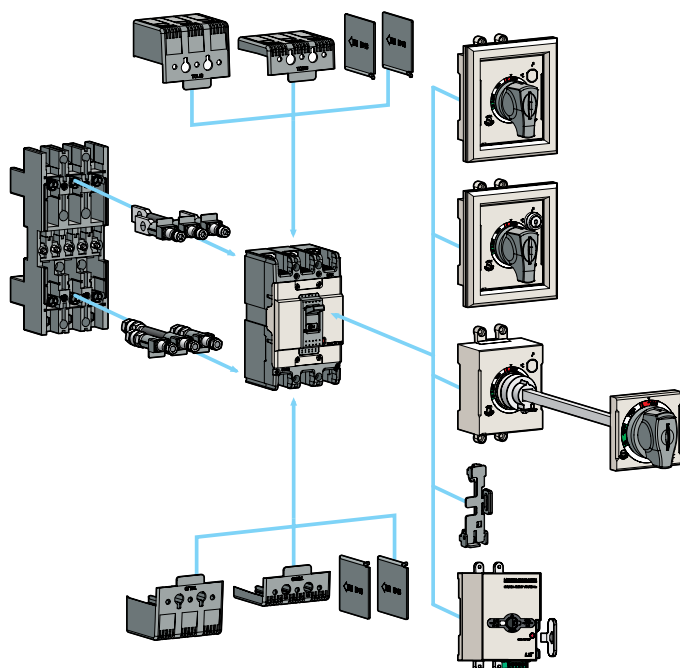

125AF MCCB

ABS125c, ABH125c, ABL125c



ABS102c



ABS103c



ABS104c

Ratings

Frame size		125AF									
Type and pole		N-type			H-type			L-type			
	2-pole	ABS102c			ABH102c			ABL102c			
	3-pole	ABS103c			ABH103c			ABL103c			
	4-pole	ABS104c			ABH104c			ABL104c			
Rated current, I _n		15-20-30-40-50-60-75-100-125A									
Rated operational voltage, U _e		AC: 690V									
		DC: 500V									
Rated insulation voltage, U _i		AC: 1000V									
Rated impulse withstand voltage, U _{imp}		8kV									
Rated short-circuit breaking capacity, I_{cu}		N-type			H-type			L-type			
AC	690V	8kA			10kA			10 (10)kA			
	480/500V	26kA			35kA			35 (35)kA			
	460V	37kA			50kA			60 (50)kA			
	415V	37kA			50kA			60 (50)kA			
	380V	42kA			50kA			60 (50)kA			
	220/250V	85kA			100kA			125 (100)kA			
	DC	500V (3P)	20kA			30kA			30 (30)kA		
	250V (2P)	20kA			30kA			30 (30)kA			
I _{cs} =%×I _{cu}		100%			100%			()			
Protective function		Overload, short-circuit									
Type of trip unit		Thermal-magnetic									
Magnetic trip range		12 × I _n (30A and under: 400A)									
Endurance	Mechanical	25,000 operations									
	Electrical	10,000 operations									
Connection	Standard	Front connection									
	Optional	Rear connection									
		Plug-in									
Mounting	Standard	Screw fixing									
Dimensions (mm)		Pole	2p	3p	4p	2p	3p	4p	2p	3p	4p
		a	60	90	120	60	90	120	60	90	120
		b	155			155			155		
		c1 <i>Note1</i>	60			60			60		
		c2 <i>Note1</i>	64			64			64		
		d	82			82			82		
Weight, kg		Standard	0.7	1	1.2	0.7	1	1.2	0.7	1	1.2
Certification		Pole	2p	3p	4p	2p	3p	4p	2p	3p	4p
CE marking		CE	○			○			○		

Note) 1. Depth by door cut size: c1 for large cut, c2 for small cut
 2. 4-pole product's ampacity on neutral conductor is equal to or less than 50% of the rated current.
 3. The I_{cs}(Service breaking capacity) of ABL125AF are in ()

For more information

- Accessories ▶ 7-1 page
- Trip curves ▶ 8-2 page
- Drawings ▶ 9-3 page
- Connection and mounting ▶ 10-2 page

Ordering types

Breaker types

ABS type (37kA/460V)			
Rated current, In	2-pole	3-pole	4-pole
15 A	ABS102c/15	ABS103c/15	ABS104c/15
20 A	ABS102c/20	ABS103c/20	ABS104c/20
30 A	ABS102c/30	ABS103c/30	ABS104c/30
40 A	ABS102c/40	ABS103c/40	ABS104c/40
50 A	ABS102c/50	ABS103c/50	ABS104c/50
60 A	ABS102c/60	ABS103c/60	ABS104c/60
75 A	ABS102c/75	ABS103c/75	ABS104c/75
100 A	ABS102c/100	ABS103c/100	ABS104c/100
125 A	ABS102c/125	ABS103c/125	ABS104c/125

ABH type (50kA/460V)			
Rated current, In	2-pole	3-pole	4-pole
15 A	ABH102c/15	ABH103c/15	ABH104c/15
20 A	ABH102c/20	ABH103c/20	ABH104c/20
30 A	ABH102c/30	ABH103c/30	ABH104c/30
40 A	ABH102c/40	ABH103c/40	ABH104c/40
50 A	ABH102c/50	ABH103c/50	ABH104c/50
60 A	ABH102c/60	ABH103c/60	ABH104c/60
75 A	ABH102c/75	ABH103c/75	ABH104c/75
100 A	ABH102c/100	ABH103c/100	ABH104c/100
125 A	ABH102c/125	ABH103c/125	ABH104c/125

ABL type (60kA/460V)			
Rated current, In	2-pole	3-pole	4-pole
15 A	ABL102c/15	ABL103c/15	ABL104c/15
20 A	ABL102c/20	ABL103c/20	ABL104c/20
30 A	ABL102c/30	ABL103c/30	ABL104c/30
40 A	ABL102c/40	ABL103c/40	ABL104c/40
50 A	ABL102c/50	ABL103c/50	ABL104c/50
60 A	ABL102c/60	ABL103c/60	ABL104c/60
75 A	ABL102c/75	ABL103c/75	ABL104c/75
100 A	ABL102c/100	ABL103c/100	ABL104c/100
125 A	ABL102c/125	ABL103c/125	ABL104c/125

Accessories

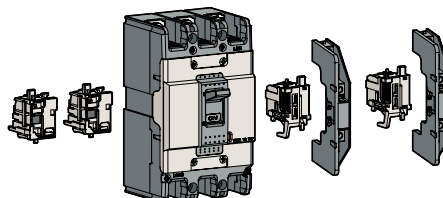

Electrical auxiliaries

AX	Auxiliary switch	
AL	Alarm switch	
AX+AL	Combination switch	
SHT	Shunt trip	
UVT	Undervoltage trip	

Maximum possibilities

T-position	One of above auxiliaries
R-position	Option of AX or AL or AX+AL

Note) For more detail see 7-1 page

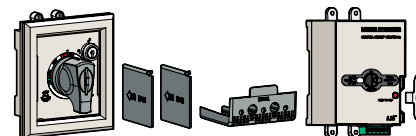

External accessories

ABS125c ABH125c	Name
IB13	Insulation barrier
TCL23	Terminal cover (Long) - Inde type, D-handle type, N-handle type
TCS23	Terminal cover (Short) - Inde type, D-handle type, N-handle type
DH125	Rotary handle (Direct)
DHK125	Rotary handle (Direct, key lock)
EH125	Rotary handle (Extended)
RTB2	Rear terminal (Bar)
RTR2	Rear terminal (Round)
PB-C3	Plug-in kit
Handle lock	
MOP-M2	Remote operation

Note) For more detail see 7-9 ~ 7-26 page

- Inde type: This cover is used without auxiliary handle.
- D-handle type: This cover is used with D-handle.
- N-handle type: This cover is used with N-handle.

250AF MCCB

ABN250c, ABS250c, ABH250c, ABL250c



ABS202c



ABS203c



ABS204c

Ratings

Frame size		250AF													
Type and pole		N-type			S-type			H-type			L-type				
2-pole		ABN202c			ABS202c			ABH202c			ABL202c				
3-pole		ABN203c			ABS203c			ABH203c			ABL203c				
4-pole		ABN204c			ABS204c			ABH204c			ABL204c				
Rated current, I _n		100-125-150-175-200-225-250A													
Rated operational voltage, U _e		AC: 690V													
		DC: 500V													
Rated insulation voltage, U _i		AC: 1000V													
Rated impulse withstand voltage, U _{imp}		8kV													
Rated short-circuit breaking capacity, I_{cu}		N-type			S-type			H-type			L-type				
AC 690V		8kA			8kA			10kA			10 (10)kA				
IEC 60947-2 (I _{cu})		480/500V			18kA			26kA			35 (35)kA				
		460V			26kA			37kA			50kA				
		415V			26kA			37kA			50kA				
		380V			30kA			42kA			50kA				
		220/250V			65kA			85kA			100kA				
DC 500V (3P)		10kA			20kA			30kA			30 (30)kA				
250V (2P)		10kA			20kA			30kA			30 (30)kA				
I _{cs} =%×I _{cu}		100%			100%			100%			()				
Protective function		Overload, short-circuit													
Type of trip unit		Thermal-magnetic													
Magnetic trip range		12×I _n													
Endurance		Mechanical			25,000 operations										
		Electrical			10,000 operations										
Connection		Standard			Front connection										
		Optional			Rear connection										
					Plug-in										
Mounting		Standard			Screw fixing										
Dimensions (mm)		Pole		2p	3p	4p	2p	3p	4p	2p	3p	4p	2p	3p	4p
		a		60	90	120	690	120	140	105	105	140	105	105	140
		b		155			155			165			165		
		c1 <i>Note1</i>		60			60			60			60		
		c2 <i>Note1</i>		64			64			64			64		
		d		82			82			87			87		
Weight, kg		Standard		0.7	1	1.2	0.7	1	1.2	1.1	1.2	1.6	1.1	1.2	1.6
Certification		Pole		2p	3p	4p	2p	3p	4p	2p	3p	4p	2p	3p	4p
CE marking		CE		○			○			○			○		

Note) 1. Depth by door cut size: c1 for large cut, c2 for small cut
 2. 4-pole product's ampacity on neutral conductor is equal to or less than 50% of the rated current.
 3. The I_{cs}(Service breaking capacity) of ABL250AF are in ()

For more information

- Accessories ▶ 7-1 page
- Trip curves ▶ 8-3 page
- Drawings ▶ 9-4 page
- Connection and mounting ▶ 10-2 page

Ordering types

Breaker types

ABN type (26kA/460V)			
Rated current, In	2-pole	3-pole	4-pole
100 A	ABN202c/100	ABN203c/100	ABN204c/100
125 A	ABN202c/125	ABN203c/125	ABN204c/125
150 A	ABN202c/150	ABN203c/150	ABN204c/150
175 A	ABN202c/175	ABN203c/175	ABN204c/175
200 A	ABN202c/200	ABN203c/200	ABN204c/200
225 A	ABN202c/225	ABN203c/225	ABN204c/225
250 A	ABN202c/250	ABN203c/250	ABN204c/250

ABS type (37kA/460V)			
Rated current, In	2-pole	3-pole	4-pole
100 A	ABS202c/100	ABS203c/100	ABS204c/100
125 A	ABS202c/125	ABS203c/125	ABS204c/125
150 A	ABS202c/150	ABS203c/150	ABS204c/150
175 A	ABS202c/175	ABS203c/175	ABS204c/175
200 A	ABS202c/200	ABS203c/200	ABS204c/200
225 A	ABS202c/225	ABS203c/225	ABS204c/225
250 A	ABS202c/250	ABS203c/250	ABS204c/250

ABH type (50kA/460V)			
Rated current, In	2-pole	3-pole	4-pole
100 A	ABH202c/100	ABH203c/100	ABH204c/100
125 A	ABH202c/125	ABH203c/125	ABH204c/125
150 A	ABH202c/150	ABH203c/150	ABH204c/150
175 A	ABH202c/175	ABH203c/175	ABH204c/175
200 A	ABH202c/200	ABH203c/200	ABH204c/200
225 A	ABH202c/225	ABH203c/225	ABH204c/225
250 A	ABH202c/250	ABH203c/250	ABH204c/250

ABL type (60kA/460V)			
Rated current, In	2-pole	3-pole	4-pole
100 A	ABL202c/100	ABL203c/100	ABL204c/100
125 A	ABL202c/125	ABL203c/125	ABL204c/125
150 A	ABL202c/150	ABL203c/150	ABL204c/150
175 A	ABL202c/175	ABL203c/175	ABL204c/175
200 A	ABL202c/200	ABL203c/200	ABL204c/200
225 A	ABL202c/225	ABL203c/225	ABL204c/225
250 A	ABL202c/250	ABL203c/250	ABL204c/250

Accessories

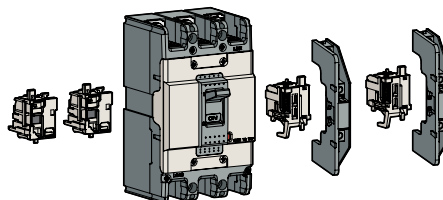

Electrical auxiliaries

AX	Auxiliary switch	
AL	Alarm switch	
AX+AL	Combination switch	
SHT	Shunt trip	
UVT	Undervoltage trip	

Maximum possibilities

T-position	One of above auxiliaries
R-position	Option of AX or AL or AX+AL

Note) For more detail see 7-1 page

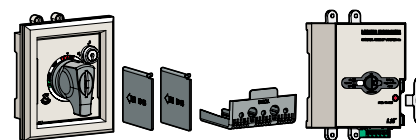

External accessories

ABH250c	Name
B33	Insulation barrier
TCL33	Terminal cover (Long) - Inde type, D-handle type, N-handle type
TCS33	Terminal cover (Short) - Inde type, D-handle type, N-handle type
DH250	Rotary handle (Direct)
DHK250	Rotary handle (Direct, key lock)
EH250	Rotary handle (Extended)
RTB3	Rear terminal (Bar)
RTR3	Rear terminal (Round)
PBA250C	Plug-in kit
Handle lock	
MOP-M3	Remote operation

Note) For more detail see 7-9 ~ 7-26 page

- Inde type: This cover is used without auxiliary handle.
- D-handle type: This cover is used with D-handle.
- N-handle type: This cover is used with N-handle.

400AF MCCB

ABN400c, ABS400c, ABH400c, ABL400c

Ratings



ABS403c



ABL404c

Frame size		400AF											
Type and pole		N-type			S-type			H-type			L-type		
2-pole		ABN402c			ABS402c			ABH402c			ABL402c		
3-pole		ABN403c			ABS403c			ABH403c			ABL403c		
4-pole		ABN404c			ABS404c			ABH404c			ABL404c		
Rated current, I _n		250-300-350-400A											
Rated operational voltage, U _e		AC: 690V											
		DC: 500V											
Rated insulation voltage, U _i		AC: 1000V											
Rated impulse withstand voltage, U _{imp}		8kV											
Rated short-circuit breaking capacity, I_{cu}		N-type			S-type			H-type			L-type		
AC 690V		5kA			8kA			10kA			14kA		
IEC 60947-2 (I _{cu})		480/500V			18kA			35kA			50kA		
		415/460V			37kA			50kA			65kA		
		380V			42kA			65kA			70kA		
		220/250V			50kA			75kA			85kA		
DC 500V (3P)		10kA			20kA			40kA			40kA		
250V (2P)		10kA			20kA			40kA			40kA		
I _{cs} =%×I _{cu}		100%			100%			100%			75		
Protective function		Overload, short-circuit											
Type of trip unit		Thermal-magnetic											
Magnetic trip range		8~12I _n											
Endurance		Mechanical			4,000 operations								
		Electrical			1,000 operations								
Connection		Standard			Front connection								
		Optional			Plug-in								
Mounting		Standard			Screw fixing								
Dimensions (mm)		Pole			2p			3p			4p		
a		140			140			184			140		
b		257			257			257			257		
c1 <small>Note)</small>		109			109			109			109		
c2 <small>Note)</small>		113			113			113			113		
d		145			145			145			145		
Weight, kg		Standard			5.2			6.2			7.8		
Certification		Pole			2p			3p			4p		
CE marking		CE			○			○			○		

Note) 1. Depth by door cut size: c1 for large cut, c2 for small cut
 2. 4-pole product's ampacity on neutral conductor is equal to or less than 50% of the rated current.

For more information

- Accessories ▶ 7-2 page
- Trip curves ▶ 8-4 page
- Drawings ▶ 9-5 page
- Connection and mounting ▶ 10-3 page

Ordering types

Breaker types

ABN type (37kA/460V)			
Rated current, In	2-pole	3-pole	4-pole
250 A	ABN402c/250	ABN403c/250	ABN404c/250
300 A	ABN402c/300	ABN403c/300	ABN404c/300
350 A	ABN402c/350	ABN403c/350	ABN404c/350
400 A	ABN402c/400	ABN403c/400	ABN404c/400

ABS type (50kA/460V)			
Rated current, In	2-pole	3-pole	4-pole
250 A	ABS402c/250	ABS403c/250	ABS404c/250
300 A	ABS402c/300	ABS403c/300	ABS404c/300
350 A	ABS402c/350	ABS403c/350	ABS404c/350
400 A	ABS402c/400	ABS403c/400	ABS404c/400

ABH type (65kA/460V)			
Rated current, In	2-pole	3-pole	4-pole
250 A	ABH402c/250	ABH403c/250	ABH404c/250
300 A	ABH402c/300	ABH403c/300	ABH404c/300
350 A	ABH402c/350	ABH403c/350	ABH404c/350
400 A	ABH402c/400	ABH403c/400	ABH404c/400

ABL type (85kA/460V)			
Rated current, In	2-pole	3-pole	4-pole
250 A	ABL402c/250	ABL403c/250	ABL404c/250
300 A	ABL402c/300	ABL403c/300	ABL404c/300
350 A	ABL402c/350	ABL403c/350	ABL404c/350
400 A	ABL402c/400	ABL403c/400	ABL404c/400

Accessories

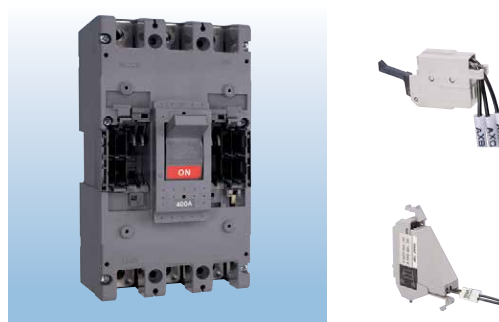

Electrical auxiliaries

AX	Auxiliary switch
AL	Alarm switch
SHT	Shunt trip
UVT	Undervoltage trip



Maximum possibilities

T-position	Option of 2AX, 2AL and SHT or UVT
R-position	Option of 2AX, 2AL and SHT or UVT

Note) For more detail see 7-2 page

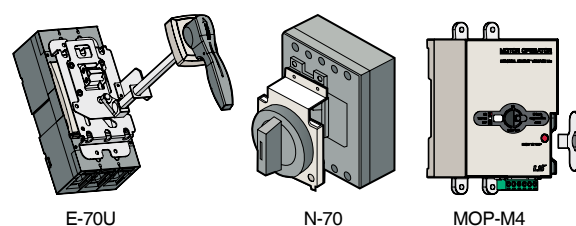

External accessories

IBL400	Insulation barrier
T1-43A	Terminal cover (Long) - 2, 3pole
T1-44A	Terminal cover (Long) - 4pole
N-70	Rotary handle (Direct)
E-70U	Rotary handle (Extended)
MI-43	Mechanical interlock - 2, 3pole
MI-44	Mechanical interlock - 4pole
PB-I3-FR	Plug-in kit
MOP-M4	Remote operation

Note) For more detail see 7-9 - 7-26 page

800AF MCCB

ABN800c, ABS800c, ABL800c



ABS803c



ABL804c

Ratings

Frame size		800AF											
Type and pole		N-type			S-type			L-type					
	2-pole	ABN802c			ABS802c			ABL802c					
	3-pole	ABN803c			ABS803c			ABL803c					
	4-pole	ABN804c			ABS804c			ABL804c					
Rated current, I _n		500-630-700-800A											
Rated operational voltage, U _e		AC: 690V											
		DC: 500V											
Rated insulation voltage, U _i		AC: 1000V											
Rated impulse withstand voltage, U _{imp}		8kV											
Rated short-circuit breaking capacity, I_{cu}		N-type			S-type			L-type					
AC	IEC 60947-2 (I _{cu})	690V	8kA	10kA	14kA								
		480/500V	25kA	45kA	65kA								
		415/460V	37kA	65kA	85kA								
		380V	45kA	75kA	100kA								
		220/250V	50kA	85kA	125kA								
DC		500V (3P)	10kA	20kA	40kA								
		250V (2P)	10kA	20kA	40kA								
I _{cs} =%×I _{cu}		100%			100%			75%					
Protective function		Overload, short-circuit											
Type of trip unit		Thermal-magnetic											
Magnetic trip range		8~12I _n											
Endurance	Mechanical	2,500 operations											
	Electrical	500 operations											
Connection	Standard	Front connection											
	Optional	Plug-in											
Mounting		Standard											
Dimensions (mm)		Pole			2p			3p			4p		
		a	210	210	280	210	210	280	210	210	280		
		b	280			280			280				
		c1 <small>Note1</small>	109			109			109				
		c2 <small>Note1</small>	113			113			113				
		d	145			145			145				
		Weight, kg	Standard	11	11.5	18.2	11	11.5	18.2	11	11.5	18.2	
Certification		Pole			2p			3p			4p		
CE marking		CE			○			○			○		

Note) 1. Depth by door cut size: c1 for large cut, c2 for small cut
 2. 4-pole product's ampacity on neutral conductor is equal to or less than 50% of the rated current.

For more information

- Accessories ▶ 7-2 page
- Trip curves ▶ 8-4 page
- Drawings ▶ 9-6 page
- Connection and mounting ▶ 10-3 page

Ordering types

Breaker types

ABN type (37kA/460V)			
Rated current, In	2-pole	3-pole	4-pole
500 A	ABN802c/500	ABN803c/500	ABN804c/500
630 A	ABN802c/630	ABN803c/630	ABN804c/630
700 A	ABN802c/700	ABN803c/700	ABN804c/700
800 A	ABN802c/800	ABN803c/800	ABN804c/800

ABS type (65kA/460V)			
Rated current, In	2-pole	3-pole	4-pole
500 A	ABS802c/500	ABS803c/500	ABS804c/500
630 A	ABS802c/630	ABS803c/630	ABS804c/630
700 A	ABS802c/700	ABS803c/700	ABS804c/700
800 A	ABS802c/800	ABS803c/800	ABS804c/800

ABL type (85kA/460V)			
Rated current, In	2-pole	3-pole	4-pole
500 A	ABL802c/500	ABL803c/500	ABL804c/500
630 A	ABL802c/630	ABL803c/630	ABL804c/630
700 A	ABL802c/700	ABL803c/700	ABL804c/700
800 A	ABL802c/800	ABL803c/800	ABL804c/800

Accessories



Electrical auxiliaries

AX	Auxiliary switch
AL	Alarm switch
SHT	Shunt trip
UVT	Undervoltage trip

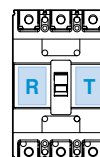

Maximum possibilities

T-position	Option of 2AX, 2AL and SHT or UVT
R-position	Option of 2AX, 2AL and SHT or UVT

Note) For more detail see 7-2 page

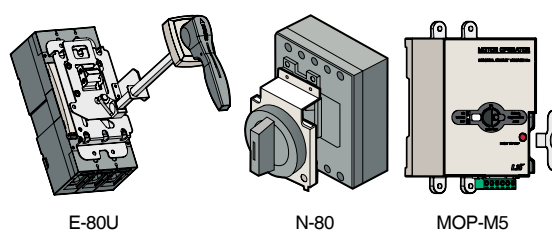

External accessories

IBL800	Insulation barrier
T1-63A	Terminal cover (Long) - 2, 3pole
T1-64A	Terminal cover (Long) - 4pole
N-80	Rotary handle (Direct)
E-80U	Rotary handle (Extended)
MI-83S	Mechanical interlock - 2, 3pole
MI-84S	Mechanical interlock - 4pole
PB-J3-FR	Plug-in kit
MOP-M5	Remote operation

Note) For more detail see 7-9 ~ 7-26 page

1000/1200AF MCCB

ABS1000b/1200b, ABL1000b/1200b



① Adjustable instantaneous for each phase

Ratings

Frame size		1000AF		1200AF		
Type and pole		S-type	L-type	S-type	L-type	
	2-pole	-	-	-	-	
	3-pole	ABS1003b	ABL1003b	ABS1203b	ABL1203b	
	4-pole	ABS1004b	ABL1004b	ABS1204b	ABL1204b	
Rated current, I _n		1000A		1200A		
Rated operational voltage, U _e		AC: 600V				
Rated insulation voltage, U _i		690V				
Rated impulse withstand voltage, U _{imp}		6kV				
Rated short-circuit breaking capacity, I_{cu}		S-type	L-type	S-type	L-type	
AC	690V	45kA	65kA	45kA	65kA	
	480/500V	50kA	75kA	50kA	75kA	
	460V/415V	65kA	85kA	65kA	85kA	
	380V	65kA	85kA	65kA	85kA	
	220/250V	100kA	125kA	100kA	125kA	
IEC 60947-2 (I _{cu})						
I _{cs} =%×I _{cu}		50%	50%	50%	50%	
Protective function		Overload, short-circuit				
Type of trip unit		Thermal-magnetic				
Magnetic trip range		3~6×I _n ...①				
Endurance	Mechanical	2,500 operations				
	Electrical	500 operations				
Connection		Standard				
Mounting		Standard				
Dimensions (mm)		Pole	3p	4p	3p	4p
	a		220	290	220	290
	b		400	400	400	400
	c		105	105	105	105
	d		159	159	159	159
Weight, kg		Standard	19.6	25.7	19.6	25.7
Certification		Pole	3p	4p	3p	4p
CE marking		ABS1003b	ABS1004b	ABS1203b	ABS1204b	
		○	×	○	×	
		ABL1003b	ABL1004b	ABL1203b	ABL1204b	
		×	×	×	×	

For more information

- Trip curves ▶ 8-5 page
- Drawings ▶ 9-7 page

Note) 1. Please specify the frequency when ordering.
 2. 4-pole product's ampacity on neutral conductor is equal to or less than 50% of the rated current.

Ordering types

Breaker types

ABS type (65kA/460V)		
Rated current, In	3-pole	4-pole
1000 A	ABS1003b/1000	ABS1004b/1000
1200 A	ABS1203b/1200	ABS1204b/1200

ABL type (85kA/460V)		
Rated current, In	3-pole	4-pole
1000 A	ABL1003b/1000	ABL1004b/1000
1200 A	ABL1203b/1200	ABL1204b/1200

Option of below items for T-position

AX1	Auxiliary switch (1c)
AX2	Auxiliary switch (2c)
AL1	Alarm switch (1c)
AL2	Alarm switch (2c)
AX1+AL	Auxiliary (1c) + Alarm (1c) switch
AX2+AL	Auxiliary (2c) + Alarm (1c) switch

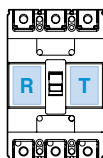

Option of below items for R-position

SHT	Shunt trip
UVT	Undervoltage trip

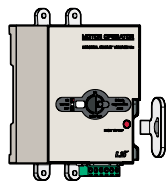

MOP-M6

External accessories

MOP-M6	Remote operation
---------------	------------------

Note) For more detail see 7-25 page

Contact operation for auxiliary and alarm switches

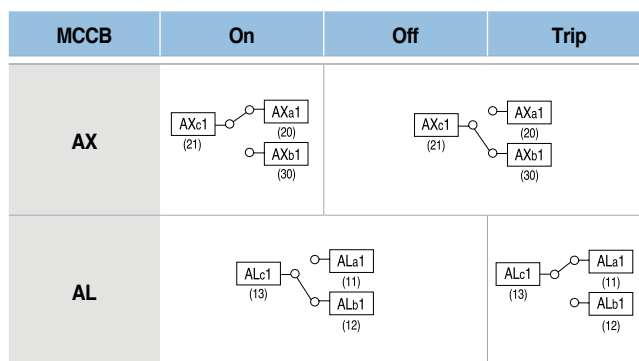

Contact rating for auxiliary and alarm switches

Voltage (V)	AC		DC		
	Current (A)		Voltage (V)	Current (A)	
	Resistive load	Inductive load		Resistive load	Inductive load
125	20	20	30	6	5
250	20	20	125	0.4	0.05
500	10	5	250	0.2	0.03

Rating for shunt trip (SHT)

	Control voltage	Time rating	Operational voltage
AC	100~110V	Continuous	85~110% of control voltage
	125V		
	200~220V		
	380~440V 480~550V		
DC	24V		75~125% of control voltage
	48V		
	100~110V		
	125V		
	200~220V		

Rating for undervoltage release (UVT)

	Control voltage	Time rating	Operational voltage	Trip voltage
AC	100~110V	Continuous	85~110% of control voltage	20~70% of control voltage
	125V			
	200~220V			
	380~440V			

1200AF Electronic MCCB

ABS1203bE

Metasol

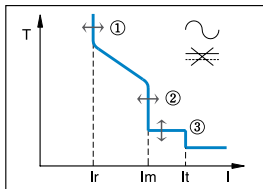
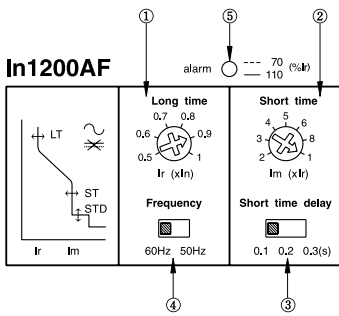

For more information

- Trip curves ▶ 8-5 page
- Drawings ▶ 9-8 page

Ratings

Frame size		1200AF	
Type and pole		S-type	
	2-pole	-	
	3-pole	ABS1203bE	
	4-pole	-	
Rated current, I_n		1200A	
Rated operational voltage, U_e		AC: 600V	
Rated insulation voltage, U_i		AC: 690V	
Rated impulse withstand voltage, U_{imp}		6kV	
Type	Long time	Current, I_R	$(0.5-0.6-0.7-0.8-0.9-1.0) \times I_n$, adjustable... ^①
	Pick-up	Time	5sec \pm 20% at $6 \times I_R$, fixed
	Short time	Current, I_m	$(2-3-4-5-6-8-10) \times I_n$, adjustable... ^②
	Pick-up	Time	0.1-0.2-0.3 sec, adjustable... ^③
	Instantaneous	Current, I_t	$11 \times I_n$, fixed
	Pick-up	Time	within 0.03 sec, fixed
	⑤ LED	Pre-alarm	Between 70 to 110% of set current I_R : LED flickering Over 110% of set current I_R : stays on
	④ Rated frequency		50-60Hz selectable by the switch of the trip unit
Rated short-circuit breaking capacity, I_{cu}		S-type	
	AC 690V	45kA	
	480/500V	50kA	
	415/460V	65kA	
	380V	65kA	
	220/250V	100kA	
$I_{cs} = \% \times I_{cu}$		50%	
Protective function		Overload, short-circuit	
Type of trip unit		Electronic type	
Endurance	Mechanical	2,500 operations	
	Electrical	500 operations	
Connection		Standard	
Mounting		Standard	
Dimensions (mm)		Pole	3p
	a	220	
	b	400	
	c	105	
	d	159	
Weight, kg		Standard	21

Ordering types

Breaker types

ABS type (65kA/460V)	
Rated current, In	3-pole
1200A	ABS1203bE

Option of below items for T-position

AX1	Auxiliary switch (1c)
AX2	Auxiliary switch (2c)
AL1	Alarm switch (1c)
AL2	Alarm switch (2c)
AX1+AL	Auxiliary (1c) + Alarm (1c) switch
AX2+AL	Auxiliary (2c) + Alarm (1c) switch

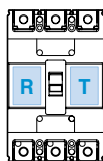

Option of below items for R-position

SHT	Shunt trip
UVT	Undervoltage trip

Contact operation for auxiliary and alarm switches

MCCB	On	Off	Trip
AX			
AL			

Contact rating for auxiliary and alarm switches

Voltage (V)	AC		DC		Inductive load
	Current (A)		Voltage (V)	Current (A)	
	Resistive load	Inductive load			Resistive load
125	20	20	30	6	5
250	20	20	125	0.4	0.05
500	10	5	250	0.2	0.03

Rating for shunt trip (SHT)

	Control voltage	Time rating	Operational voltage
AC	100~110V 125V 200~220V 380~440V 480~550V	Continuous	85~110% of control voltage
DC	24V 48V 100~110V 125V 200~220V		75~125% of control voltage

Rating for undervoltage release (UVT)

	Control voltage	Time rating	Operational voltage	trip voltage
AC	100~110V 125V 200~220V 380~440V	Continuous	85~110% of control voltage	20~70% of control voltage

30AF ELCB

EBS30c

Metasol



EBS33c

Ratings

Frame size		30AF			
Type and pole		S-type			
	2-pole (2-sensor)	EBS32c			
	3-pole (3-sensor)	EBS33c			
	4-pole (3-sensor)	EBS34c			
Rated current, I _n		(5-10) ^{Note3} -15-20-30A			
Rated impulse withstand voltage, U _{imp}		6kV			
Instantaneous type	Rated residual current, I Δ n	30, 100, 100/200/500, 100/300/500mA (Adjustable)			
	Residual current off-time at I Δ n	≤0.1 sec			
	Rated operational voltage, U _e	AC: 220/460V			
Time delay type	Rated residual current	1A	0.1/0.2/0.5/1		
	Intentional time delay	1s	0/0.2/0.5/1		
	Rated residual current	2A	0.1/0.4/1/2		
Wiring system	Intentional time delay	2s	0.5/1/1.5/2		
	2-pole (2-sensor)	1Ø2W			
	3-pole (3-sensor)	1Ø2W, 1Ø3W, 3Ø3W			
	4-pole (3-sensor)	1Ø2W, 1Ø3W, 3Ø3W, 3Ø4W			
Rated short-circuit breaking capacity, I_{cu}		S-type			
AC	460V	14 (10)kA			
	415V	14 (10)kA			
	220/250V	30 (25)kA			
I _{cs} =%×I _{cu}		100%			
Protective function		Overload, short-circuit and ground fault			
Type of trip unit		Thermal-magnetic			
Magnetic trip range		400A			
Endurance	Mechanical	25,000 operations			
	Electrical	10,000 operations			
Connection	Standard	Front connection			
	Optional	Rear connection			
Mounting		Standard Screw fixing			
Dimensions (mm)		Pole	2p	3p	4p
	a			75	100
	b			130	130
	c1 ^{Note1}			60	60
	c2 ^{Note1}			64	64
	d			82	82
	Weight, kg	Standard	0.5	0.7	0.9
Certification		Pole	3p	4p	
CE marking		Ⓒ Ⓔ	○	○	

For more information

- Accessories ▶ 7-1 page
- Trip curves ▶ 8-1 page
- Drawings ▶ 9-9 page
- Connection and mounting ▶ 10-2 page

- Note) 1. Depth by door cut size: c1 for large cut, c2 for small cut
 2. Do not test withstand voltage or insulation resistance test between poles to avoid the damage of the PCB.
 3. The short-circuit breaking capacities in () are applied to the rated current in (5, 10A)
 4. 4-pole product's ampacity on neutral conductor is equal to or less than 50% of the rated current.
 5. Rated non-trip current sensitivity is equal to or less than 50% of the rated current sensitivity.

Ordering types

Breaker types

Instantaneous type

EBS33c		/		5		/		30	
Code	Frame size/ Pole	Code	Rated current	Code	Rated residual current				
EBS32c	EBS 30AF 2P	5	5A	30	30mA				
EBS33c	EBS 30AF 3P	10	10A	100	100mA				
EBS34c	EBS 30AF 4P	15	15A	100/200/500	100/200/500mA				
		20	20A	100/300/500	100/300/500mA				
		25	25A						
		30	30A						

Note) EBS32c/5/30: EBS32c, Rated current 5A, Rated residual current 30mA

Time delay type

EBS33c		/		5		/		1A1s	
Code	Frame size/ Pole	Code	Rated current	Code	Rated residual current	Intentional time delay			
EBS32c	EBS 30AF 2P	5	5A	1A1s	1A	1s			
EBS33c	EBS 30AF 3P	10	10A	2A2s	2A	2s			
EBS34c	EBS 30AF 4P	15	15A						
		20	20A						
		25	25A						
		30	30A						

Note) EBS32c/5/30: EBS32c, Rated current 5A, Time delay type 1A1s

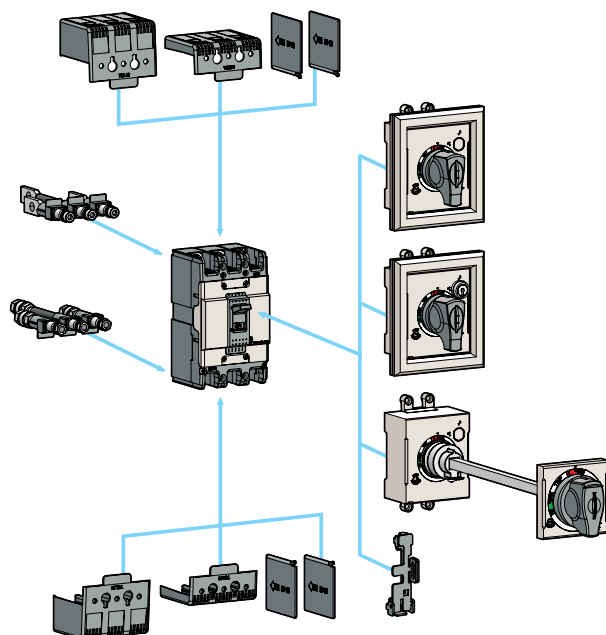

Accessories

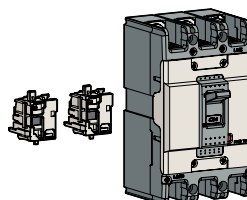

Electrical auxiliaries

AX	Auxiliary switch
AL	Alarm switch
AX+AL	Combination switch

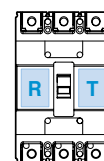

Maximum possibilities

T-position	Not available
R-position	Option of AX or AL or AX+AL

Note) For more detail see 7-1 page

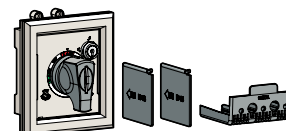

External accessories

EBS30c	Name
IB13	Insulation barrier
TCL13	Terminal cover (Long) - Inde type, D-handle type, N-handle type
TCS13	Terminal cover (Short) - Inde type, D-handle type, N-handle type
DH100	Rotary handle (Direct)
DHK100	Rotary handle (Direct, key lock)
EH100	Rotary handle (Extended)
RTR1	Rear terminal (Bar)
Handle lock	

Note) For more detail see 7-9 ~ 7-23 page

- Inde type: This cover is used without auxiliary handle.
- D-handle type: This cover is used with D-handle.
- N-handle type: This cover is used with N-handle.

50AF ELCB

EBN50c, EBS50c, EBH50c



EBN53c



EBS53c

Ratings

Frame size		50AF						
Type and pole				N-type	S-type	H-type		
2-pole (2-sensor)				EBN52c	-	-		
3-pole (3-sensor)				EBN53c	EBS53c	EBH53c		
4-pole (3-sensor)				-	EBS54c	EBH54c		
Rated current, I _n		15-20-30-40-50A						
Rated impulse withstand voltage, U _{imp}		6kV						
Instantaneous type	Rated residual current, I _{Δn}	30, 100, 100/200/500, 100/300/500mA (Adjustable)						
	Residual current off-time at I _{Δn}	≤0.1 sec						
	Rated operational voltage, U _e	AC: 220/460V						
Time delay type	Rated residual current 1A			0.1/0.2/0.5/1				
	Intentional time delay 1s			0/0.2/0.5/1				
	Rated residual current 2A			0.1/0.4/1/2				
Wiring system	Intentional time delay 2s			0.5/1/1.5/2				
	2-pole (2-sensor)			1Ø2W				
3-pole (3-sensor)				1Ø2W, 1Ø3W, 3Ø3W				
4-pole (3-sensor)				1Ø2W, 1Ø3W, 3Ø3W, 3Ø4W				
Rated short-circuit breaking capacity, I_{cu}				N-type	S-type	H-type		
AC	460V			14kA	18kA	50kA		
	415V			14kA	18kA	50kA		
	220/250V			30kA	35kA	100kA		
I _{cs} =%×I _{cu}				100%	100%	100%		
Protective function		Overload, short-circuit and ground fault						
Type of trip unit		Thermal-magnetic						
Magnetic trip range		12 × I _n (30A and under: 400A)						
Endurance	Mechanical	25,000 operations						
	Electrical	10,000 operations						
Connection	Standard	Front connection						
	Optional	Rear connection						
Mounting		Standard		Screw fixing				
Dimensions (mm)		Pole	2p	3p	3p	4p	3p	4p
		a	75	75	75	100	90	120
		b	130		130		155	
		c1 <i>Note1</i>	60		60		60	
		c2 <i>Note1</i>	64		64		64	
		d	82		82		82	
		Weight, kg	Standard	0.5	0.7	0.7	0.9	1
Certification		Pole	2p	3p	3p	4p	3p	4p
CE marking		CE	○	○	○	○	○	

For more information

- Accessories ▶ 7-1 page
- Trip curves ▶ 8-1 ~ 8-2 page
- Drawings ▶ 9-9 ~ 9-10 page
- Connection and mounting ▶ 10-2 page

Note) 1. Depth by door cut size: c1 for large cut, c2 for small cut
 2. Do not test withstand voltage or insulation resistance test between poles to avoid the damage of the PCB.
 3. 4-pole product's ampacity on neutral conductor is equal to or less than 50% of the rated current.
 4. Rated non-trip current sensitivity is equal to or less than 50% of the rated current sensitivity.

Ordering types

Breaker types

Instantaneous type

EBN53c		/		20		/		30	
Code	Frame size/ Pole	Code	Rated current	Code	Rated residual current	Code	Rated residual current	Code	Rated residual current
EBN52c	EBN 50AF 2P	15	15A	30	30mA				
EBN53c	EBN 50AF 3P	20	20A	100	100mA				
EBS53c	EBS 50AF 3P	30	30A	100/200/500	100/200/500mA				
EBS54c	EBS 50AF 4P	40	40A	100/300/500	100/300/500mA				
EBH53c	EBH 50AF 3P	50	50A						
EBH54c	EBH 50AF 4P								

Note) EBS53c/20/30: EBS53c, Rated current 20A, Rated residual current 30mA

Time delay type

EBN53c		/		20		/		1A1s	
Code	Frame size/ Pole	Code	Rated current	Code	Rated residual current	Intentional time delay	Code	Rated residual current	Intentional time delay
EBN52c	EBN 50AF 2P	15	15A	1A1s	1A	1s			
EBN53c	EBN 50AF 3P	20	20A	2A2s	2A	2s			
EBS53c	EBS 50AF 3P	30	30A						
EBS54c	EBS 50AF 4P	40	40A						
EBH53c	EBH 50AF 3P	50	50A						
EBH54c	EBH 50AF 4P								

Note) EBS53c/20/30: EBS53c, Rated current 20A, Time delay type 1A1s

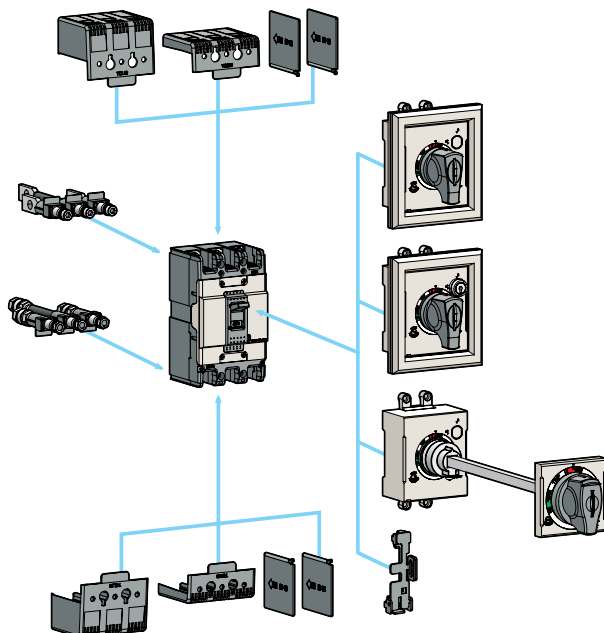

Accessories

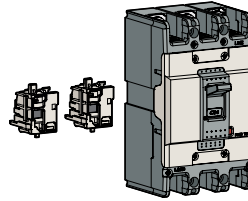

Electrical auxiliaries

AX	Auxiliary switch
AL	Alarm switch
AX+AL	Combination switch

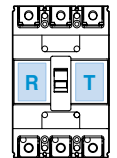

Maximum possibilities

T-position	Not available
R-position	Option of AX or AL or AX+AL

Note) For more detail see 7-1 page

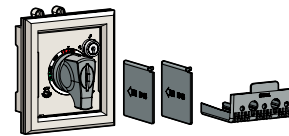

External accessories

EBN50c EBS50c	EBH50c	Name
IB13	IB23	Insulation barrier
TCL13	TCL23	Terminal cover (Long) - Inde type, D-handle type, N-handle type
TCS13	TCS23	Terminal cover (Short) - Inde type, D-handle type, N-handle type
DH100	DH125	Rotary handle (Direct)
DHK100	DHK125	Rotary handle (Direct, key lock)
EH100	EH125	Rotary handle (Extended)
-	RTB2	Rear terminal (Bar)
RTR1	RTR2	Rear terminal (Round)
Handle lock		

Note) For more detail see 7-9 ~ 7-23 page

- Inde type: This cover is used without auxiliary handle.
- D-handle type: This cover is used with D-handle.
- N-handle type: This cover is used with N-handle.

60AF ELCB

EBN60c, EBS60c



EBN63c



EBS63c

Ratings

Frame size		60AF			
Type and pole		N-type		S-type	
	2-pole (2-sensor)	-		-	
	3-pole (3-sensor)	EBN63c		EBS63c	
	4-pole (3-sensor)	-		EBS64c	
Rated current, I _n		60A			
Rated impulse withstand voltage, U _{imp}		6kV			
Instantaneous type	Rated residual current, I _{Δn}	30, 100, 100/200/500, 100/300/500mA (Adjustable)			
	Residual current off-time at I _{Δn}	≤0.1 sec			
	Rated operational voltage, U _e	AC: 220/460V			
Time delay type	Rated residual current 1A	0.1/0.2/0.5/1			
	Intentional time delay 1s	0/0.2/0.5/1			
	Rated residual current 2A	0.1/0.4/1/2			
	Intentional time delay 2s	0.5/1/1.5/2			
Wiring system	2-pole (2-sensor)	-			
	3-pole (3-sensor)	1Ø2W, 1Ø3W, 3Ø3W			
	4-pole (3-sensor)	1Ø2W, 1Ø3W, 3Ø3W, 3Ø4W			
Rated short-circuit breaking capacity, I_{cu}		N-type		S-type	
AC	460V	14kA		18kA	
	415V	14kA		18kA	
	220/250V	30kA		35kA	
I _{cs} =%×I _{cu}		100%		100%	
Protective function		Overload, short-circuit and ground fault			
Type of trip unit		Thermal-magnetic			
Magnetic trip range		12×I _n			
Endurance	Mechanical	25,000 operations			
	Electrical	10,000 operations			
Connection	Standard	Front connection			
	Optional	Rear connection			
Mounting		Standard Screw fixing			
Dimensions (mm)		Pole	3p	3p	4p
		a	75	75	100
		b	130	130	130
		c1 <small>Note1)</small>	60	60	60
		c2 <small>Note1)</small>	64	64	64
		d	82	82	82
		Weight, kg	Standard	0.7	0.7
Certification		Pole	3p	3p	4p
CE marking		CE	○	○	○

For more information

- Accessories ▶ 7-1 page
- Trip curves ▶ 8-1 page
- Drawings ▶ 9-9 page
- Connection and mounting ▶ 10-2 page

Note) 1. Depth by door cut size: c1 for large cut, c2 for small cut
 2. Do not test withstand voltage or insulation resistance test between poles to avoid the damage of the PCB.
 3. 4-pole product's ampacity on neutral conductor is equal to or less than 50% of the rated current.
 4. Rated non-trip current sensitivity is equal to or less than 50% of the rated current sensitivity.

Ordering types

Breaker types

Instantaneous type

EBN63c		/		60		/		30	
Code	Frame size/ Pole	Code	Rated current	Code	Rated residual current	Code	Rated residual current	Code	Rated residual current
EBN63c	EBN 60AF 3P	60	60A	30	30mA	100/200/500	100/200/500mA	100	100mA
EBS63c	EBS 60AF 3P			100/300/500	100/300/500mA				
EBS64c	EBS 60AF 4P								

Note) EBS63c/60/30: EBS63c, Rated current 60A, Rated residual current 30mA

Time delay type

EBN63c		/		60		/		1A1s	
Code	Frame size/ Pole	Code	Rated current	Code	Rated residual current	Code	Rated residual current	Intentional time delay	
EBN63c	EBN 60AF 3P	60	60A	1A1s	1A	1s			
EBS63c	EBS 60AF 3P			2A2s	2A	2s			
EBS64c	EBS 60AF 4P								

Note) EBS63c/60/30: EBS63c, Rated current 60A, Time delay type 1A1s

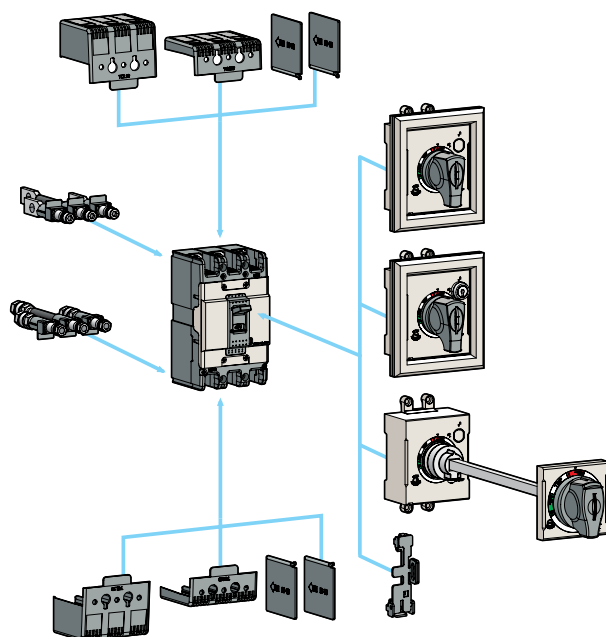

Accessories

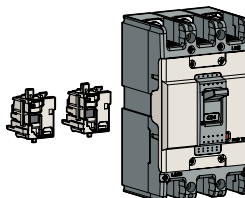

Electrical auxiliaries

AX	Auxiliary switch
AL	Alarm switch
AX+AL	Combination switch

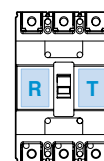

Maximum possibilities

T-position	Not available
R-position	Option of AX or AL or AX+AL

Note) For more detail see 7-1 page

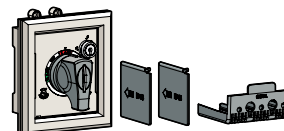

External accessories

EBS60c EBN60c	Name
IB13	Insulation barrier
TCL13	Terminal cover (Long) - Inde type, D-handle type, N-handle type
TCS13	Terminal cover (Short) - Inde type, D-handle type, N-handle type
DH100	Rotary handle (Direct)
DHK100	Rotary handle (Direct, key lock)
EH100	Rotary handle (Extended)
RTB1	Rear terminal (Bar)
RTR1	Rear terminal (Round)
Handle lock	

Note) For more detail see 7-9 ~ 7-23 page

- Inde type: This cover is used without auxiliary handle.
- D-handle type: This cover is used with D-handle.
- N-handle type: This cover is used with N-handle.

100AF ELCB

EBN100c

Metasol



EBN103c

Ratings

Frame size		100AF			
Type and pole		N-type			
	2-pole (2-sensor)				EBN102c
	3-pole (3-sensor)				EBN103c
	4-pole (3-sensor)				EBN104c
Rated current, I _n		60-75-100A			
Rated impulse withstand voltage, U _{imp}		6kV			
Instantaneous type	Rated residual current, I _{Δn}	30, 100, 100/200/500, 100/300/500mA (Adjustable)			
	Residual current off-time at I _{Δn}	≤0.1 sec			
	Rated operational voltage, U _e	AC: 220/460V			
Time delay type	Rated residual current 1A				0.1/0.2/0.5/1
	Intentional time delay 1s				0/0.2/0.5/1
	Rated residual current 2A				0.1/0.4/1/2
	Intentional time delay 2s				0.5/1/1.5/2
	Wiring system	2-pole (2-sensor)	1Ø2W		
	3-pole (3-sensor)	1Ø2W, 1Ø3W, 3Ø3W			
	4-pole (3-sensor)	1Ø2W, 1Ø3W, 3Ø3W, 3Ø4W			
Rated short-circuit breaking capacity, I_{cu}		N-type			
AC	460V				18kA
	415V				18kA
	220/250V				35kA
I _{cs} =%×I _{cu}		100%			
Protective function		Overload, short-circuit and ground fault			
Type of trip unit		Thermal-magnetic			
Magnetic trip range		12 × I _n			
Endurance	Mechanical				25,000 operations
	Electrical				10,000 operations
Connection	Standard				Front connection
	Optional				Rear connection
Mounting		Standard Screw fixing			
Dimensions (mm)		Pole	2p	3p	4p
	a		75	75	100
	b		130	130	130
	c1 <small>Note1)</small>		60	60	60
	c2 <small>Note1)</small>		64	64	64
	d		82	82	82
	Weight, kg	Standard	0.5	0.7	0.9
Certification		Pole	2p	3p	4p
CE marking		☒	○	○	○

For more information

- Accessories ▶ 7-1 page
- Trip curves ▶ 8-1 page
- Drawings ▶ 9-9 page
- Connection and mounting ▶ 10-2 page

Note) 1. Depth by door cut size: c1 for large cut, c2 for small cut
 2. Do not test withstand voltage or insulation resistance test between poles to avoid the damage of the PCB.
 3. 4-pole product's ampacity on neutral conductor is equal to or less than 50% of the rated current.
 4. Rated non-trip current sensitivity is equal to or less than 50% of the rated current sensitivity.

Ordering types

Breaker types

Instantaneous type

EBN103c		/	100		/	30	
Code	Frame size/ Pole	Code	Rated current	Code	Rated residual current		
EBN102c	EBN 100AF 2P	60	60A	30	30mA		
EBN103c	EBN 100AF 3P	75	75A	100	100mA		
EBN104c	EBN 100AF 4P	100	100A	100/200/500	100/200/500mA		
				100/300/500	100/300/500mA		

Note) EBN103c/100/30: EBN103c, Rated current 100A, Rated residual current 30mA

Time delay type

EBN103c		/	100		/	1A1s	
Code	Frame size/ Pole	Code	Rated current	Code	Rated residual current	Intentional time delay	
EBN102c	EBN 100AF 2P	60	60A	1A1s	1A	1s	
EBN103c	EBN 100AF 3P	75	75A	2A2s	2A	2s	
EBN104c	EBN 100AF 4P	100	100A				

Note) EBN103c/100/30: EBN103c, Rated current 100A, Time delay type 1A1s

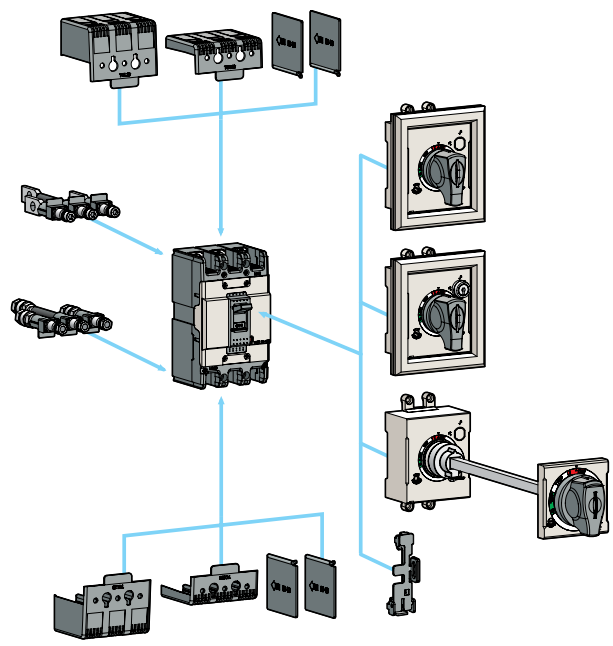

Accessories

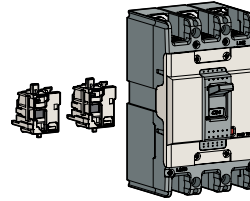

Electrical auxiliaries

AX	Auxiliary switch
AL	Alarm switch
AX+AL	Combination switch

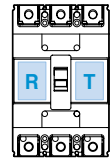

Maximum possibilities

T-position	Not available
R-position	Option of AX or AL or AX+AL

Note) For more detail see 7-1 page

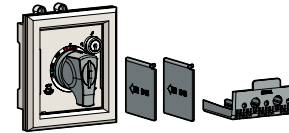

External accessories

EBN100c	Name
IB13	Insulation barrier
TCL13	Terminal cover (Long) - Inde type, D-handle type, N-handle type
TCS13	Terminal cover (Short) - Inde type, D-handle type, N-handle type
DH100	Rotary handle (Direct)
DHK100	Rotary handle (Direct, key lock)
EH100	Rotary handle (Extended)
RTB1	Rear terminal (Bar)
RTR1	Rear terminal (Round)
Handle lock	

Note) For more detail see 7-9~ 7-23 page Note) For more detail see 82 page

- Inde type: This cover is used without auxiliary handle.
- D-handle type: This cover is used with D-handle.
- N-handle type: This cover is used with N-handle.

125AF ELCB

EBS125c, EBH125c



EBS103c



EBH103c

Ratings

Frame size		125AF				
Type and pole		S-type		H-type		
	2-pole (2-sensor)	-		-		
	3-pole (3-sensor)	EBS103c		EBH103c		
	4-pole (3-sensor)	EBS104c		EBH104c		
Rated current, I _n		15-20-30-40-50-60-75-100-125A				
Rated impulse withstand voltage, U _{imp}		6kV				
Instantaneous type	Rated residual current, I _{Δn}	30, 100, 100/200/500, 100/300/500mA (Adjustable)				
	Residual current off-time at I _{Δn}	≤0.1 sec				
	Rated operational voltage, U _e	AC: 220/460V				
Time delay type	Rated residual current 1A	0.1/0.2/0.5/1				
	Intentional time delay 1s	0/0.2/0.5/1				
	Rated residual current 2A	0.1/0.4/1/2				
	Intentional time delay 2s	0.5/1/1.5/2				
Wiring system	2-pole (2-sensor)	-				
	3-pole (3-sensor)	1Ø2W, 1Ø3W, 3Ø3W				
	4-pole (3-sensor)	1Ø2W, 1Ø3W, 3Ø3W, 3Ø4W				
Rated short-circuit breaking capacity, I_{cu}		N-type		S-type		
AC	460V	37kA		50kA		
	415V	37kA		50kA		
	220/250V	85kA		100kA		
I _{cs} =%×I _{cu}		100%		100%		
Protective function		Overload, short-circuit and ground fault				
Type of trip unit		Thermal-magnetic				
Magnetic trip range		12×I _n (30A and under: 400A)				
Endurance	Mechanical	25,000 operations				
	Electrical	10,000 operations				
Connection	Standard	Front connection				
	Optional	Rear connection				
Mounting		Standard Screw fixing				
Dimensions (mm)		Pole	3p	4p	3p	4p
	a	90	120	90	120	
	b	155	155	155	155	
	c1 <small>Note1)</small>	60	60	60	60	
	c2 <small>Note1)</small>	64	64	64	64	
	d	82	82	82	82	
	Weight, kg	Standard	1	1.2	1	1.2
Certification		Pole	3p	4p	3p	4p
CE marking		CE	○	○	○	○

For more information

- Accessories ▶ 7-1 page
- Trip curves ▶ 8-2 page
- Drawings ▶ 9-10 page
- Connection and mounting ▶ 10-2 page

Note) 1. Depth by door cut size: c1 for large cut, c2 for small cut
 2. Do not test withstand voltage or insulation resistance test between poles to avoid the damage of the PCB.
 3. 4-pole product's ampacity on neutral conductor is equal to or less than 50% of the rated current.
 4. Rated non-trip current sensitivity is equal to or less than 50% of the rated current sensitivity.

Ordering types

Breaker types

Instantaneous type

EBS103c		/		100		/		30	
Code	Frame size/ Pole	Code	Rated current	Code	Rated residual current				
EBS103c	EBS 125AF 3P	15	15A	30	30mA				
EBS104c	EBS 125AF 4P	20	20A	100	100mA				
EBH103c	EBH 125AF 3P	30	30A	100/200/500	100/200/500mA				
EBH104c	EBH 125AF 4P	40	40A	100/300/500	100/300/500mA				
		50	50A						
		60	60A						
		75	75A						
		100	100A						
		125	125A						

Note) EBS103c/100/30: EBS103c, Rated current 100A, Rated residual current 30mA

Time delay type

EBS103c		/		100		/		1A1s	
Code	Frame size/ Pole	Code	Rated current	Code	Rated residual current	Intentional time delay			
EBS103c	EBS 125AF 3P	15	15A	1A1s	1A	1s			
EBS104c	EBS 125AF 4P	20	20A	2A2s	2A	2s			
EBH103c	EBH 125AF 3P	30	30A						
EBH104c	EBH 125AF 4P	40	40A						
		50	50A						
		60	60A						
		75	75A						
		100	100A						
		125	125A						

Note) EBS103c/100/30: EBS103c, Rated current 100A, Time delay type 1A1s

Accessories

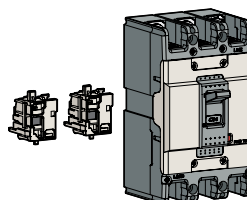

Electrical auxiliaries

AX	Auxiliary switch
AL	Alarm switch
AX+AL	Combination switch

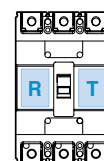

Maximum possibilities

T-position	Not available
R-position	Option of AX or AL or AX+AL

Note) For more detail see 7-1 page

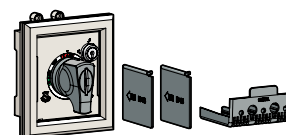

External accessories

EBS60c EBN60c	Name
IB23	Insulation barrier
TCL23	Terminal cover (Long) - Inde type, D-handle type, N-handle type
TCS23	Terminal cover (Short) - Inde type, D-handle type, N-handle type
DH125	Rotary handle (Direct)
DHK125	Rotary handle (Direct, key lock)
EH125	Rotary handle (Extended)
RTB2	Rear terminal (Bar)
RTR2	Rear terminal (Round)
Handle lock	

Note) For more detail see 7-9 ~ 7-23 page

- Inde type: This cover is used without auxiliary handle.
- D-handle type: This cover is used with D-handle.
- N-handle type: This cover is used with N-handle.

250AF ELCB

EBN250c, EBS250c, EBH250c



EBN203c



EBS203c

Ratings

Frame size		250AF									
Type and pole		N-type		S-type		H-type					
	2-pole (2-sensor)	EBN202c		-		-					
	3-pole (3-sensor)	EBN203c		EBS203c		EBH203c					
	4-pole (3-sensor)	-		EBS204c		EBH204c					
Rated current, I _n		100-125-150-175-200-225-250A									
Rated impulse withstand voltage, U _{imp}		6kV									
Instantaneous type	Rated residual current, I _{Δn}	30, 100, 100/200/500, 100/300/500mA (Adjustable)									
	Residual current off-time at I _{Δn}	≤0.1 sec									
	Rated operational voltage, U _e	AC: 220/460V									
Time delay type	Rated residual current 1A	0.1/0.2/0.5/1									
	Intentional time delay 1s	0/0.2/0.5/1									
	Rated residual current 2A	0.1/0.4/1/2									
	Intentional time delay 2s	0.5/1/1.5/2									
Wiring system	2-pole (2-sensor)	1Ø2W									
	3-pole (3-sensor)	1Ø2W, 1Ø3W, 3Ø3W									
	4-pole (3-sensor)	1Ø2W, 1Ø3W, 3Ø3W, 3Ø4W									
Rated short-circuit breaking capacity, I_{cu}		N-type		S-type		H-type					
AC	460V	26kA		37kA		50kA					
	415V	26kA		37kA		50kA					
	220/250V	65kA		85kA		100kA					
I _{cs} =%×I _{cu}		100%		100%		100%					
Protective function		Overload, short-circuit and ground fault									
Type of trip unit		Thermal-magnetic									
Magnetic trip range		12×I _n									
Endurance	Mechanical	20,000 operations									
	Electrical	5,000 operations									
Connection	Standard	Front connection									
	Optional	Rear connection									
Mounting		Standard Screw fixing									
Dimensions (mm)		Pole		2p		3p		3p		4p	
		a		105		105		105		140	
		b		165		165		165		165	
		c1 <small>Note1</small>		60		60		60		60	
		c2 <small>Note1</small>		64		64		64		64	
		d		87		87		87		87	
Weight, kg		Standard		1.1		1.2		1.2		1.5	
Certification		Pole		2p		3p		3p		4p	
CE marking		☐		○		○		○		○	

For more information

- Accessories ▶ 7-1 page
- Trip curves ▶ 8-3 page
- Drawings ▶ 9-11 page
- Connection and mounting ▶ 10-2 page

Note) 1. Depth by door cut size: c1 for large cut, c2 for small cut
 2. Do not test withstand voltage or insulation resistance test between poles to avoid the damage of the PCB.
 3. 4-pole product's ampacity on neutral conductor is equal to or less than 50% of the rated current.
 4. Rated non-trip current sensitivity is equal to or less than 50% of the rated current sensitivity.

Ordering types

Breaker types

Instantaneous type

EBS203c		/		250		/		30	
Code	Frame size/ Pole	Code	Rated current	Code	Rated residual current				
EBN202c	EBN 250AF 2P	100	100A	30	30mA				
EBN203c	EBN 250AF 3P	125	125A	100	100mA				
EBS203c	EBS 250AF 3P	150	150A	100/200/500	100/200/500mA				
EBS204c	EBS 250AF 4P	175	175A	100/300/500	100/300/500mA				
EBH203c	EBH 250AF 3P	200	200A						
EBH204c	EBH 125AF 4P	225	225A						
		250	250A						

Note) EBS203c/250/30: EBS203c, Rated current 250A, Rated residual current 30mA

Time delay type

EBS203c		/		250		/		1A1s	
Code	Frame size/ Pole	Code	Rated current	Code	Rated residual current	Intentional time delay			
EBN202c	EBN 250AF 2P	100	100A	1A1s	1A	1s			
EBN203c	EBN 250AF 3P	125	125A	2A2s	2A	2s			
EBS203c	EBS 250AF 3P	150	150A						
EBS204c	EBS 250AF 4P	175	175A						
EBH203c	EBH 250AF 3P	200	200A						
EBH204c	EBH 125AF 4P	225	225A						
		250	250A						

Note) EBS203c/250/30: EBS203c, Rated current 250A, Time delay type 1A1s

Accessories

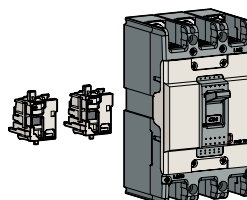

Electrical auxiliaries

AX	Auxiliary switch
AL	Alarm switch
AX+AL	Combination switch

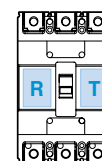

Maximum possibilities

T-position	Not available
R-position	Option of AX or AL or AX+AL

Note) For more detail see 7-1 page

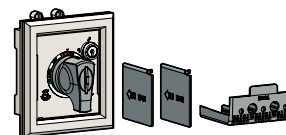

External accessories

EBN250c EBS250c EBH250c	Name
IB23	Insulation barrier
TCL33	Terminal cover (Long) - Inde type, D-handle type, N-handle type
TCS33	Terminal cover (Short) - Inde type, D-handle type, N-handle type
DH250	Rotary handle (Direct)
DHK250	Rotary handle (Direct, key lock)
EH250	Rotary handle (Extended)
RTB3	Rear terminal (Bar)
RTR3	Rear terminal (Round)
Handle lock	

Note) For more detail see 7-9 ~ 7-23 page

- Inde type: This cover is used without auxiliary handle.
- D-handle type: This cover is used with D-handle.
- N-handle type: This cover is used with N-handle.

400AF ELCB

EBN400c, EBS400c, EBH400c, EBL400c



EBS403c



EBL404c

Ratings

Frame size		400AF									
Type and pole		N-type		S-type		H-type		L-type			
3-pole (3-sensor)		EBN403c		EBS403c		EBH403c		EBL403c			
4-pole (3-sensor)		EBN404c		EBS404c		EBH404c		EBL404c			
Rated current, I _n		250-300-350-400A									
Rated residual current, I _{Δn}		30, 100/200/500mA (Adjustable)									
Residual current off-time at I _{Δn}		≤0.1 sec									
Rated operational voltage, U _e		220/460V									
Rated impulse withstand voltage, U _{imp}		6kV									
Wiring system		3-pole (3-sensor)		1Ø2W, 1Ø3W, 3Ø3W							
		4-pole (3-sensor)		1Ø2W, 1Ø3W, 3Ø3W, 3Ø4W							
Rated short-circuit breaking capacity, I_{cu}		N-type		S-type		H-type		L-type			
AC		415V/460V		37kA		50kA		65kA			
		220/250V		50kA		75kA		85kA			
I _{cs} =%×I _{cu}		100%		100%		100%		75%			
Protective function		Overload, short-circuit and ground fault									
Type of trip unit		Thermal-magnetic									
Magnetic trip range		8-12I _n									
Endurance		Mechanical		4,000 operations							
		Electrical		1,000 operations							
Connection		Standard		Front connection							
Mounting		Standard		Screw fixing							
Dimensions (mm)		Pole		3p		4p		3p		4p	
a				140		184		140		184	
b				257		257		257		257	
c1 <small>Note 1</small>				109		109		109		109	
c2 <small>Note 1</small>				113		113		113		113	
d				145		145		145		145	
Weight, kg		Standard		7		8.4		7		8.4	
Certification		Pole		3p		4p		3p		4p	
CE marking		☐		○		○		○		○	

Note) 1. Depth by door cut size: c1 for large cut, c2 for small cut
 2. Do not test withstand voltage or insulation resistance test between poles to avoid the damage of the PCB.
 3. 4-pole product's ampacity on neutral conductor is equal to or less than 50% of the rated current.
 4. Rated non-trip current sensitivity is equal to or less than 50% of the rated current sensitivity.

For more information

- Accessories ▶ 7-2 page
- Trip curves ▶ 8-4 page
- Drawings ▶ 9-12 page
- Connection and mounting ▶ 10-3 page

Ordering types

Breaker types

EBN type (25kA/460V)

Rated current, I _n	Rated residual current, I _{Δn} : 30mA		Rated residual current, I _{Δn} : 100/200/500mA	
	3-pole	4-pole	3-pole	4-pole
250 A	EBN403c/250/30	EBN404c/250/30	EBN403c/250/100	EBN404c/250/100
300 A	EBN403c/300/30	EBN404c/300/30	EBN403c/300/100	EBN404c/300/100
350 A	EBN403c/350/30	EBN404c/350/30	EBN403c/350/100	EBN404c/350/100
400 A	EBN403c/400/30	EBN404c/400/30	EBN403c/400/100	EBN404c/400/100

EBS type (50kA/460V)

Rated current, I _n	Rated residual current, I _{Δn} : 30mA		Rated residual current, I _{Δn} : 100/200/500mA	
	3-pole	4-pole	3-pole	4-pole
250 A	EBS403c/250/30	EBS404c/250/30	EBS403c/250/100	EBS404c/250/100
300 A	EBS403c/300/30	EBS404c/300/30	EBS403c/300/100	EBS404c/300/100
350 A	EBS403c/350/30	EBS404c/350/30	EBS403c/350/100	EBS404c/350/100
400 A	EBS403c/400/30	EBS404c/400/30	EBS403c/400/100	EBS404c/400/100

EBH type (65kA/460V)

Rated current, I _n	Rated residual current, I _{Δn} : 30mA		Rated residual current, I _{Δn} : 100/200/500mA	
	3-pole	4-pole	3-pole	4-pole
250 A	EBH403c/250/30	EBH404c/250/30	EBH403c/250/100	EBH404c/250/100
300 A	EBH403c/300/30	EBH404c/300/30	EBH403c/300/100	EBH404c/300/100
350 A	EBH403c/350/30	EBH404c/350/30	EBH403c/350/100	EBH404c/350/100
400 A	EBH403c/400/30	EBH404c/400/30	EBH403c/400/100	EBH404c/400/100

EBL type (85kA/460V)

Rated current, I _n	Rated residual current, I _{Δn} : 30mA		Rated residual current, I _{Δn} : 100/200/500mA	
	3-pole	4-pole	3-pole	4-pole
250 A	EBL403c/250/30	EBL404c/250/30	EBL403c/250/100	EBL404c/250/100
300 A	EBL403c/300/30	EBL404c/300/30	EBL403c/300/100	EBL404c/300/100
350 A	EBL403c/350/30	EBL404c/350/30	EBL403c/350/100	EBL404c/350/100
400 A	EBL403c/400/30	EBL404c/400/30	EBL403c/400/100	EBL404c/400/100

Accessories

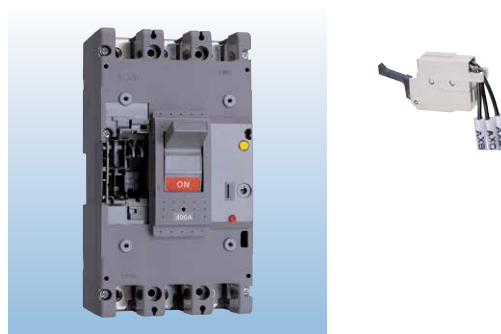

Electrical auxiliaries

AX	Auxiliary switch
AL	Alarm switch
SHT	Shunt trip
UVT	Undervoltage trip

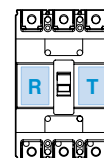

Maximum possibilities

T-position	Not available
R-position	Option of 2AX, 2AL and SHT or UVT

Note) For more detail see 7-2 page

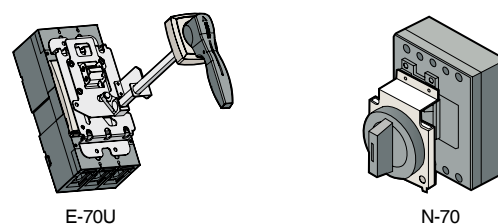

External accessories

IBL400	Insulation barrier
T1-43A	Terminal cover (Long) - 2, 3pole
T1-44A	Terminal cover (Long) - 4pole
N-70	Rotary handle (Direct)
E-70U	Rotary handle (Extended)
MI-43	Mechanical interlock - 2, 3pole
MI-44	Mechanical interlock - 4pole

Note) For more detail see 7-9 ~ 7-23 page

800AF ELCB

EBN803c, EBS803c, EBL803c



EBS803c

Ratings

Frame size		800AF		
Type and pole		N-type	S-type	L-type
	3-pole (3-sensor)	EBN803c	EBS803c	EBL803c
	4-pole (3-sensor)	-	-	-
Rated current, I _n		500-630-700-800A		
Rated residual current, I _{Δn}		30, 100/200/500mA (Adjustable)		
Residual current off-time at I _{Δn}		≤0.1 sec		
Rated operational voltage, U _e		220/460V		
Rated impulse withstand voltage, U _{imp}		6 kV		
Wiring system	3-pole (3-sensor)	1Ø2W, 1Ø3W, 3Ø3W		
	4-pole (3-sensor)	-		
Rated short-circuit breaking capacity, I_{cu}		N-type	S-type	L-type
AC	415/460V	37kA	65kA	85kA
	220/250V	50kA	85kA	125kA
I _{cs} =%×I _{cu}		100%	100%	75%
Protective function		Overload, short-circuit and ground fault		
Type of trip unit		Thermal-magnetic		
Magnetic trip range		8~12I _n		
Endurance	Mechanical	2,500 operations		
	Electrical	500 operations		
Connection	Standard	Front connection		
Mounting	Standard	Screw fixing		
Dimensions (mm)		Pole	3p	
	a	210		
	b	280		
	c1 <i>Note1</i>	109		
	c2 <i>Note1</i>	113		
	d	145		
	Weight, kg	Standard	11.5	
Certification		Pole	3p	
CE marking		CE	○	

For more information

- Accessories ▶ 7-2 page
- Trip curves ▶ 8-4 page
- Drawings ▶ 9-13 page
- Connection and mounting ▶ 10-3 page

*Note) 1. Depth by door cut size: c1 for large cut, c2 for small cut
 2. Do not test withstand voltage or insulation resistance test between poles to avoid the damage of the PCB.
 3. Rated non-trip current sensitivity is equal to or less than 50% of the rated current sensitivity.*

Ordering types

Breaker types

EBN type (37kA/460V)		
Rated current, I _n	Rated residual current, I _{Δn} : 30mA	Rated residual current, I _{Δn} : 100/200/500mA
	3-pole	3-pole
500 A	EBN803c/500/30	EBN803c/500/100
630 A	EBN803c/630/30	EBN803c/630/100
700 A	EBN803c/700/30	EBN803c/700/100
800 A	EBN803c/800/30	EBN803c/800/100

EBS type (65kA/460V)		
Rated current, I _n	Rated residual current, I _{Δn} : 30mA	Rated residual current, I _{Δn} : 100/200/500mA
	3-pole	3-pole
500 A	EBS803c/500/30	EBS803c/500/100
630 A	EBS803c/630/30	EBS803c/630/100
700 A	EBS803c/700/30	EBS803c/700/100
800 A	EBS803c/800/30	EBS803c/800/100

EBL type (85kA/460V)		
Rated current, I _n	Rated residual current, I _{Δn} : 30mA	Rated residual current, I _{Δn} : 100/200/500mA
	3-pole	3-pole
500 A	EBL803c/500/30	EBL803c/500/100
630 A	EBL803c/630/30	EBL803c/630/100
700 A	EBL803c/700/30	EBL803c/700/100
800 A	EBL803c/800/30	EBL803c/800/100

Accessories

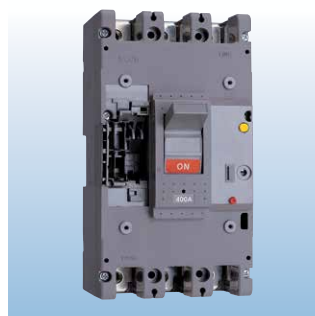

Electrical auxiliaries

AX	Auxiliary switch
AL	Alarm switch
SHT	Shunt trip
UVT	Undervoltage trip

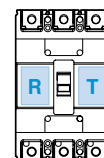

Maximum possibilities

T-position	Not available
R-position	Option of 2AX, 2AL and SHT or UVT

Note) For more detail see 7-2 page

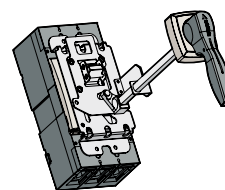

E-80U

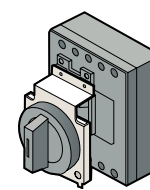

N-80

External accessories

IBL800	Insulation barrier
T1-63A	Terminal cover (Long) - 2, 3pole
T1-64A	Terminal cover (Long) - 4pole
N-80	Rotary handle (Direct)
E-80U	Rotary handle (Extended)
MI-83S	Mechanical interlock - 2, 3pole
MI-84S	Mechanical interlock - 4pole

Note) For more detail see 7-9 ~ 7-23 page

1000/1200AF ELCB

EBS1003b, EBS1203b



① Adjustable instantaneous for each phase

For more information

- Trip curves ▶ 8-5 page
- Drawings ▶ 9-14 page

Ratings

Frame size		1000AF	1200AF
Type and pole		S-type	
	3-pole (3-sensor)	EBS1003b	EBS1203b
	4-pole (3-sensor)	-	-
Rated current, I _n		1000A	1200A
Rated residual current, I _{Δn}		100/200/500mA (Adjustable)	
Residual current off-time at I _{Δn}		≤0.1 sec	
Rated operational voltage, U _e		AC: 460V	
Wiring system 3-pole (3-sensor)		1Ø2W, 1Ø3W, 3Ø3W	
Rated short-circuit breaking capacity, I_{cu}		S-Type	S-Type
	AC	415/460V	85kA
		220/250V	125kA
Protective function		Overload, short-circuit and ground fault	
Type of trip unit		Thermal-magnetic	
Magnetic trip range		3-6 × I _n ...①	
Endurance	Mechanical	2,500 operations	
	Electrical	500 operations	
Connection		Standard	
Mounting		Standard	
Dimensions (mm)		Pole	3p
		a	220
		b	565
		c	105
		d	159
		Weight, kg	Standard

Note) 1. Do not test withstand voltage or insulation resistance test between poles to avoid the damage of the PCB.
 2. Rated non-trip current sensitivity is equal to or less than 50% of the rated current sensitivity.

Ordering types

Breaker types

EBS type (85kA/460V)	
Rated current, In	3-pole
1000 A	EBS1003b/1,000/100
1200 A	EBS1203b/1200/100

Contact operation for auxiliary and alarm switches

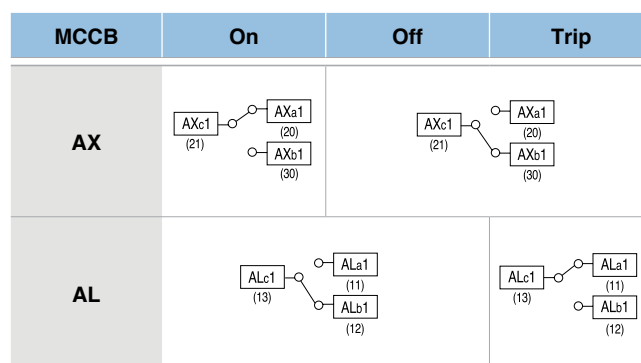

Option of below items for T-position

AX1	Auxiliary switch (1c)
AL1	Alarm switch (1c)
AX1+AL1	Auxiliary (1c) + Alarm (1c) switch

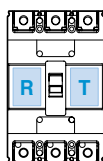

Note) R-position is not available.

Contact rating for auxiliary and alarm switches

Voltage (V)	AC		Voltage (V)	DC	
	Current (A)			Current (A)	
	Resistive load	Inductive load		Resistive load	Inductive load
125	20	20	30	6	5
250	20	20	125	0.4	0.05
500	10	5	250	0.2	0.03

Electrical auxiliaries of 100~250AF

Option of connecting AX or AL or AX+AL
This seat is not available for 2-pole MCCB.

Option of connecting SHT or UVT
or AX or AL or AX+AL
This seat is not available for ELCB.

Maximum possibilities

Position	Type	ABN100c		ABH125c		ABH250c	EBN100c	EBH125c	EBH250c
		2p	3/4p	2p	3/4p	2/3/4p	2/3/4p	3/4p	2/3/4p
Left-hand seat	AX	-	1	-	1	1	1	1	1
	AL	-	1	-	1	1	1	1	1
	AX+AL	-	1	-	1	1	1	1	1
Right-hand seat	AX	1	1	1	1	1	-	-	-
	AL	1	1	1	1	1	-	-	-
	AX+AL	1	1	1	1	1	-	-	-
	SHT/UVT	1	1	1	1	1	-	-	-

Electrical auxiliaries of 400~800AF

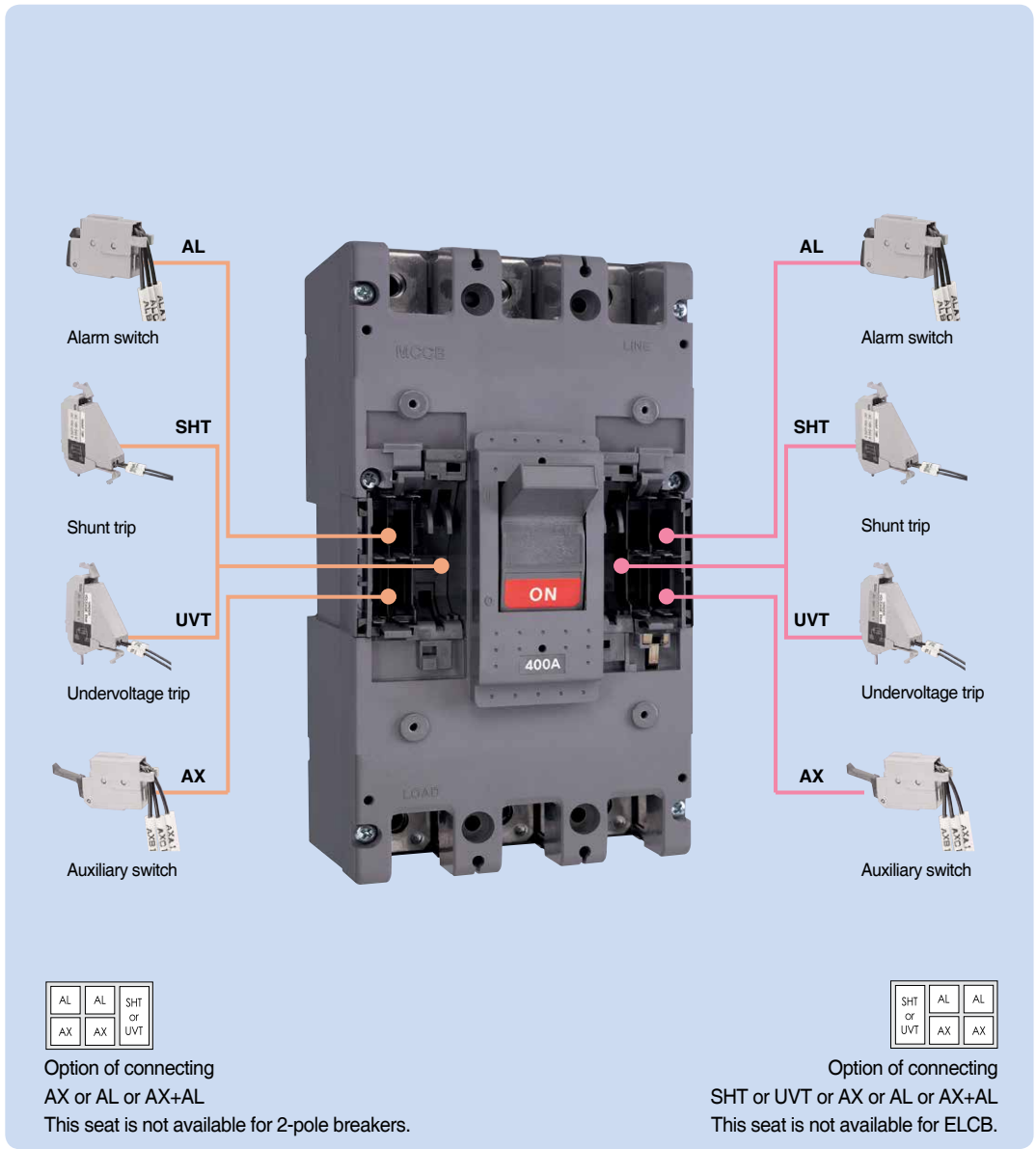

Maximum possibilities

Position	Type	MCCB (400~800AF)	ELCB (400~800AF)
Left-hand seat	AX	2	2
	AL	2	2
	SHT/UVT	1	1
Right-hand seat	AX	2	-
	AL	2	-
	SHT/UVT	1	-

Accessories

Combinations of accessories

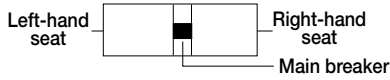

○ Auxiliary switch (AX)

● Alarm switch (AL)

□ Shunt trip (SHT) / Undervoltage trip (UVT)

Series	MCCB (30~250AF)				MCCB (400~800AF)	MCCB (1,000~1200AF)	
Type	N-type	ABE 32b	ABE 33b	ABN 52c ABN 62c ABN 102c/102d/102e	ABN 53c/54c ABN 63c/64c ABN 103c/104c, ABN 103e/104e ABN 202c/203c/204c	ABN 402c/403c/404c ABN 802c/803c/804c	-
	S-type	-	-	ABS 32c ABS 52c ABS 62c ABS 102c	ABS 33c/34c ABS 53c/54c ABS 63c/64c ABS 103c/104c ABS 202c/203c/204c	ABS 402c/403c/404c ABS 802c/803c/804c	ABS 1003b ABS 1004b ABS 1203b ABS 1204b ABS 1203bE
	H-type	-	-	ABH 52c ABH 102c	ABH 53c/54c ABH 103c/104c ABH202c/203c/204c	ABH 402c/403c/404c	-
	L-type	-	-	ABL 102c	ABL 103c/104c ABL 202c/203c/204c	ABL 402c/403c/404c ABL 802c/803c/804c	ABL 1003b ABL 1004b ABL 1203b ABL 1204b
Pole	2 pole	3 pole	2 pole	2, 3, 4 pole		2, 3, 4 pole	3, 4 pole
AX							
AX2							
AX3 (4)							
AL							
AL2							
AL3 (4)							
SHT (UVT)							
SHT (UVT) 2							
AX+AL							
AX+AL2							
AX+AL3 (4)							
AX2+AL							
AX2+AL2							
AX2+AL3 (4)							
AX3 (4) +AL							
AX3 (4) +AL2							
AX3 (4) +AL3 (4)							
AX+SHT (UVT)							

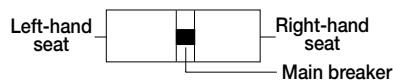

- Auxiliary switch (AX)
- Alarm switch (AL) □ Shunt trip (SHT) / Undervoltage trip (UVT)

Series		MCCB (30~250AF)			MCCB (400~800AF)	MCCB (1,000~1200AF)	
Type	N-type	ABE 32b	ABE 33b	ABN 52c ABN 62c ABN 102c/102d/102e	ABN 53c/54c ABN 63c/64c ABN 103c/104c, ABN 103e/104e ABN 202c/203c/204c	ABN 402c/403c/404c ABN 802c/803c/804c	-
	S-type	-	-	ABS 32c ABS 52c ABS 62c ABS 102c	ABS 33c/34c ABS 53c/54c ABS 63c/64c ABS 103c/104c ABS 202c/203c/204c	ABS 402c/403c/404c ABS 802c/803c/804c	ABS 1003b ABS 1004b ABS 1203b ABS 1204b ABS 1203bE
	H-type	-	-	ABH 52c ABH 102c	ABH 53c/54c ABH 103c/104c ABH202c/203c/204c	ABH 402c/403c/404c	-
	L-type	-	-	ABL 102c	ABL 103c/104c ABL 202c/203c/204c	ABL 402c/403c/404c ABL 802c/803c/804c	ABL 1003b ABL 1004b ABL 1203b ABL 1204b
Pole		2 pole	3 pole	2 pole	2, 3, 4 pole	2, 3, 4 pole	3, 4 pole
AX+SHT (UVT) 2							
AX2+SHT (UVT)							
AX2+SHT (UVT) 2							
AX3 (4)+SHT (UVT)							
AX3 (4)+SHT (UVT) 2							
AL+SHT (UVT)							
AL+SHT (UVT) 2							
AL2+SHT (UVT)							
AL2+SHT (UVT) 2							
AL3 (4) +SHT (UVT)							
AL3 (4) +SHT (UVT) 2							
AX+AL+SHT (UVT)							
AX+AL+SHT (UVT) 2							
AX2+AL2+SHT (UVT)							
AX2+AL2+SHT (UVT) 2							
AX3 (4)+AL3 (4)+SHT (UVT)							
AX3 (4)+AL3 (4)+SHT (UVT) 2							

Accessories

Combinations of accessories

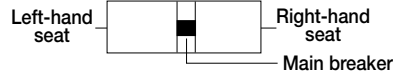

- Auxiliary switch (AX)
- Alarm switch (AL) Shunt trip (SHT) / Undervoltage trip (UVT)

Series		ELCB (30~250AF)	ELCB (400~800AF)	ELCB (1,000~1200AF)
Type	N-type	EBN 52c/53c/54c EBN 63c EBN 102c/103c/104c EBN 202c/203c	EBN 403c/404c EBN 803c	-
	S-type	EBS 32c/33c/34c EBS 53c/54c EBS 63c/64c EBS 103c/104c EBS 203c/204c	EBS 403c/404c EBS 803c	EBS 1003b EBS 1203b
	H-type	EBH 53c/54c EBH 53c/54c EBH 103c/104c	EBH 403c/404c	-
	L-type	-	EBL 403c/404c EBL 803c	-
Pole		3, 4 pole	3 pole	3 pole
AX				
AX2				
AL				
AL2				
SHT (UVT)				
AX+AL				
AX+AL2				
AX2+AL				
AX2+AL2				
AX+SHT (UVT)				
AX2+SHT (UVT)				
AL+SHT (UVT)				
AL2+SHT (UVT)				
AX+AL+SHT (UVT)				
AX2+AL2+SHT (UVT)				

Test lead wire (30~250AF)

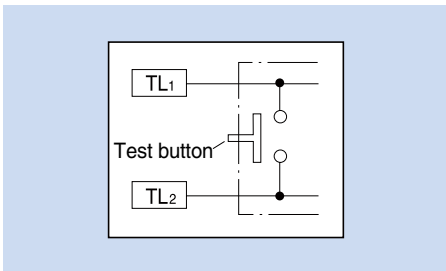

- Note) 1. When you touch the lead wire under energized condition, you will be in danger of electric shock.
 2. Do not energize on both ends of lead wire.
 3. Do not pull out the lead wire excessively or impact on the product.

Terminal block type

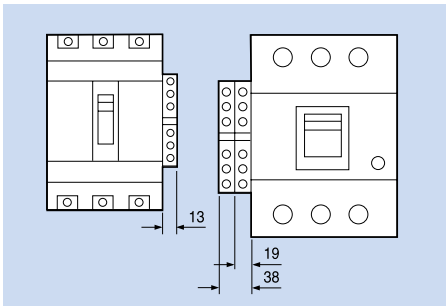

Auxiliary and alarm switch

Auxiliary switch (AX)



Auxiliary switch is for applications requiring remote "On" and "Off" indication. Each switch contains two contacts having a common connection. One is open and the other closed when the circuit breaker is open, and viceversa.

Alarm switch (AL)



Alarm switches offer provisions for immediate audio or visual indication of a tripped breaker due to overload, short circuit, shunt trip, or undervoltage release conditions. They are particularly useful in automated plants where operators must be signaled about changes in the electrical distribution system. This switch features a closed contact when the circuit breaker is tripped automatically. In other words, this switch does not function when the breaker is operated manually. Its contact is open when the circuit breaker is reset.

Combination switch (AX+AL)

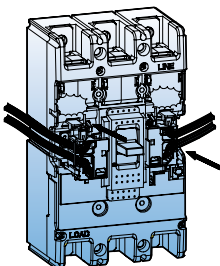

It consists of one auxiliary switch (AX) and one alarm switch (AL) in a body to connect into the same position of the breaker.

Contact (AX+AL)

MCCB	On	Off	Trip
AX			
AL			

Rating (AX+AL)

Conventional thermal current, I _{th}		5A				
Rated operational current, I _e	Voltage, U _e	Current, I _e				
		Resistive load	Inductive load	Minimum laod current	Applicable MCCB/ELCB	
AC 50/60Hz	125V	5	3	5V DC 160mA 30V DC 30mA	Metasol MCCB/ ELCB 30~800AF	
	250V	3	2			
	500V	-	-			
DC	30V	4	3	5V DC 160mA 30V DC 30mA		Metasol MCCB/ ELCB 30~800AF
	125V	0.4	0.4			
	250V	0.2	0.2			

Shunt trip, SHT

The shunt trip opens the mechanism in response to an externally applied voltage signal. The releases include coil clearing contacts that automatically clear the signal circuit when the breaker has tripped. This is not available for ELCBs of 30~250AF .

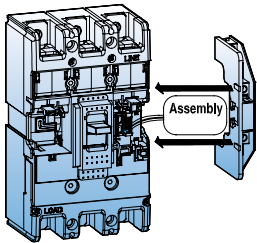

Rating for 30~250AF

Control voltage, Ue	Power consumption		MCCB/ELCB
	AC (VA)	DC (W)	
DC 12V	-	1.5	Metasol MCCB ABN100c ABH125c ABH250c
AC/DC 24~30V	1.5	1.5	
AC/DC 48~60V	1.5	1.5	
Voltage AC/DC 100~130V	1.5	1.5	
AC/DC 200~250V	1.5	1.5	
AC 380~450V	1.5	-	
AC 440~500V	1.5	-	
Max. opening time	50ms (max.)		
Tightening torque of terminal screw	8.2 kgf · cm		

Note: 1. Range of operational voltage: 0.7 ~ 1.1Vn
Frequency (Only AC) : 45Hz ~ 65Hz



Terminal block type (TBT)



Lead wire type (LWT)

Rating for 400~800AF

Control voltage, Ue	Power consumption		
	V	mA	W
AC/DC 24~48	AC 24	14	0.3
AC 100~240/DC 100~220	DC 24	15.4	0.4
AC 380~550	AC 48	14	0.7
	DC 48	16	0.8
	AC 110	6	0.7
	DC 110	6.6	0.7
	AC 220	6.8	1.5
	DC 200	7.6	1.5
	AC 440	4.3	1.9
	AC 480	4.4	3.3
	AC 550	4.6	2.4

Note: Range of operational voltage
AC: 0.85 ~ 1.1Vn
DC: 0.75 ~ 1.25Vn



Lead wire type (LWT)

Undervoltage release, UVT

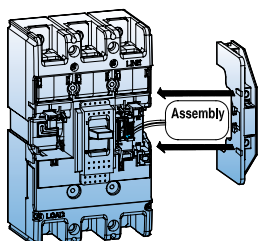

The undervoltage release automatically opens a circuit breaker when voltage drops to a value ranging between 20% to 70% of the line voltage. The operation is instantaneous, and after tripping, the circuit breaker cannot be re-closed again until the voltage returns to 85% of line voltage.

Continuously energized, the undervoltage release must be operating before the circuit breaker can be closed. This is not available for ELCBs of 30~250AF .

- Range of tripping voltage: 0.2 ~ 0.7Vn
- Reset and closing of a breaker is possible when the control voltage is over 0.85Vn
- Frequency (Only AC: 45Hz ~ 65Hz)

Rating for 30~250AF



Terminal block type (TBT)

Control voltage, Ue		Power consumption		
		AC (VA)	DC (W)	mA
Voltage	AC/DC 24V	0.64	0.65	27
	AC/DC 48V	1.09	1.1	23
	AC/DC 100~110V	0.73	0.75	5.8
	AC/DC 200~220V	1.21	1.35	5.4
	AC 380~440V	1.67	-	3.8
	AC 440~480V	1.68	-	3.5
Max.opening time		50ms (max.)		
Tightening torque of terminal screw		8.2 kgf · cm		
Operating voltage range	Trip	20~70% Vn		
	Reset/Closing	≥ 0.85Vn		

Rating for 400~800AF



Lead wire type (LWT)

Control voltage, Ue	Trip voltage	Reset/closing voltage	Time rating
AC/DC 48	· AC: 85~1.1Vn · DC: 85~1.25Vn	· AC: 0.2~0.7Vn · DC: 0.2~0.7Vn	Continuous
AC/DC 100~125			
AC 200~240 / DC 200~240			
AC 380~440			
AC 440~480			

Terminal numbering

Auxiliary switch (AX)	Alarm switch (AL)	Shunt trip (SHT)	Undervoltage trip (UVT)

Accessories

External accessories

Wide range of external accessories provides user-friendly solution for mounting, cable connection, insulation, safety lock and remote control.

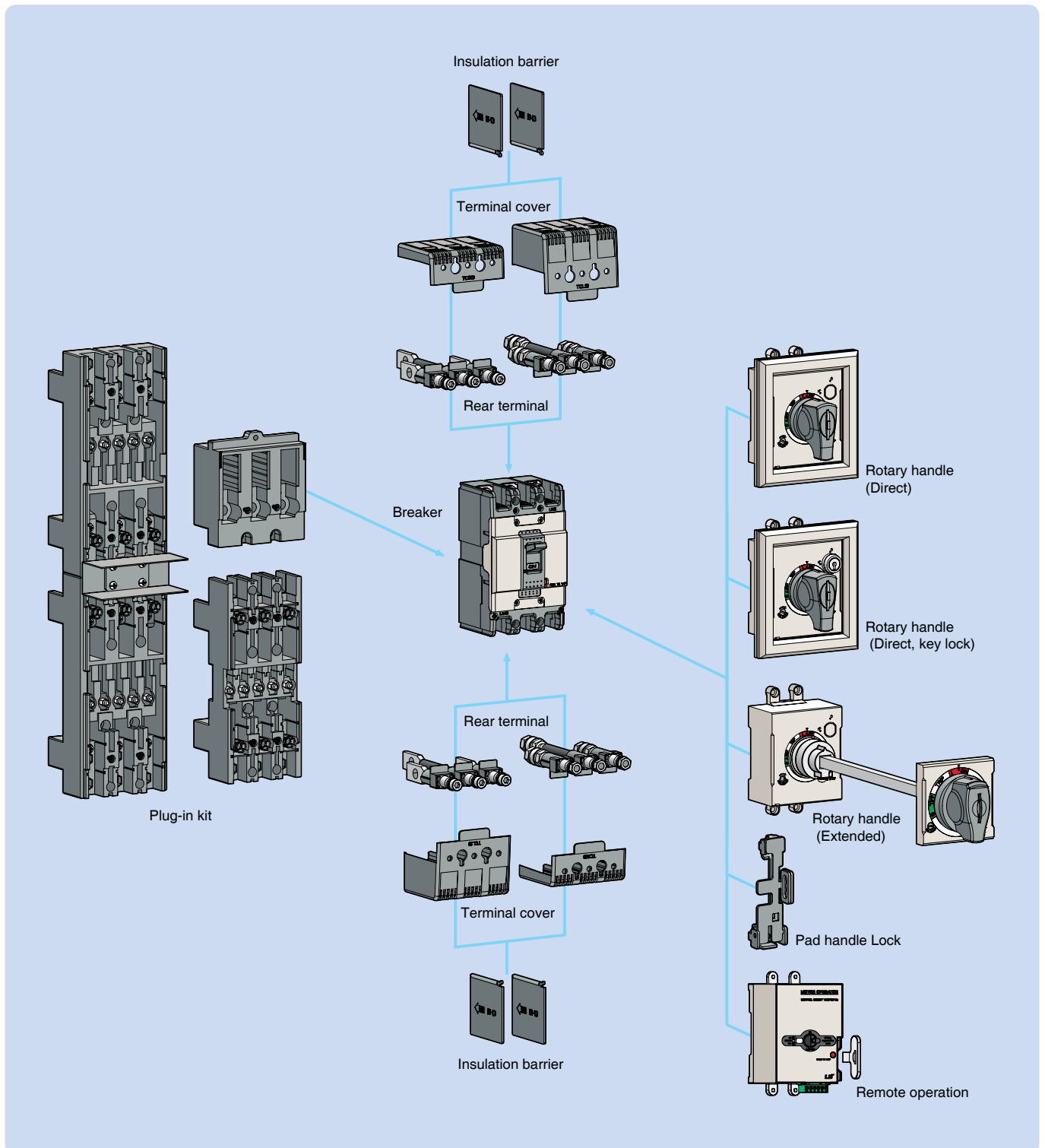

Rotary handles

Direct type



Direct type
(DH 30~250AF)



Key lock
(DH 30~250AF)



(N 30~250AF)

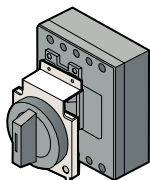

(N 400~800AF)

Extended type



(30~250AF)

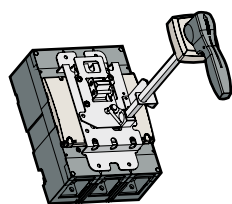

(400~800AF)

The rotary handle operating mechanism is available in either the direct version or in the extended version on the compartment door. It is always fitted with a compartment door lock and on a request it can be supplied with a key lock in the open position.

Direct type , D-handle and N-handle

- D-handle: Directly mountable to a circuit breaker. Trip button is built as standard. Key lock type is optional.
- N-handle: Directly mountable to a circuit breaker. Door is locked in the Off state. handle size is greater than D-handle.

Extended type, E-handle

It is used in case direct type handle can not be applied because of the longer distance between the breaker and the panel door.

Type

Direct type	Direct type (Key lock)	Extended type	Breaker type	
			MCCB	ELCB
N-30c	-	-	ABN50c/60c/100c/100e	EBN50c/60c/100c
DH100	DHK100	EH100	ABS30c/50c/60c	EBS30c/50c/60c
N-40c	-	-	ABS125c ABH50c/125c ABL125c	EBS125c EBH50c/125c
N-50c	-	-	ABN/S/H/L250c	EBN/S/H250c
DH250	DHK250	EH250	ABN/S/H/L400c	EBN/S/H/L400c
N-70	-	E-70U	ABN/S/L800c	EBN/S/L800c
N-80	-	E-80U	ABN/S/L800c	EBN/S/L800c

Note: Padlock type for N-handle
 - On or Off state type - Only Off state type

Type suffix according to the mounting position

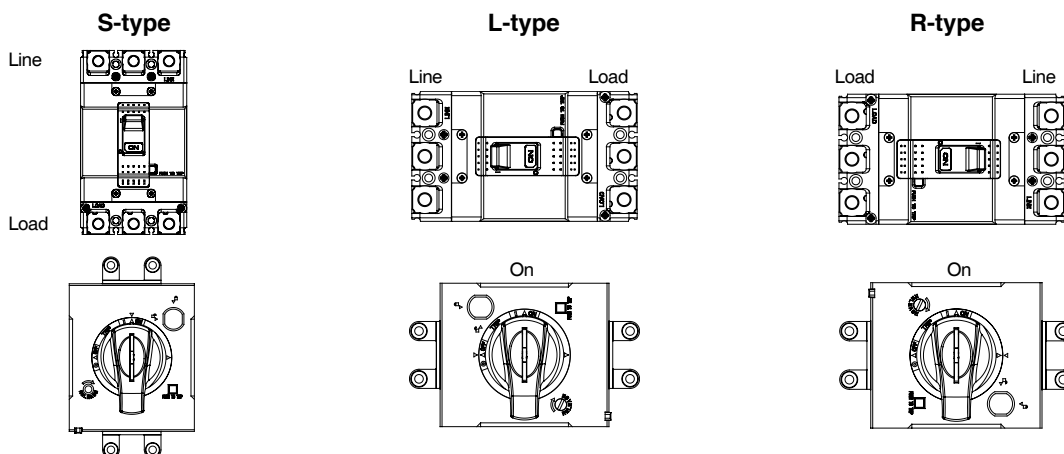

D-handle

MCCB and D-handle

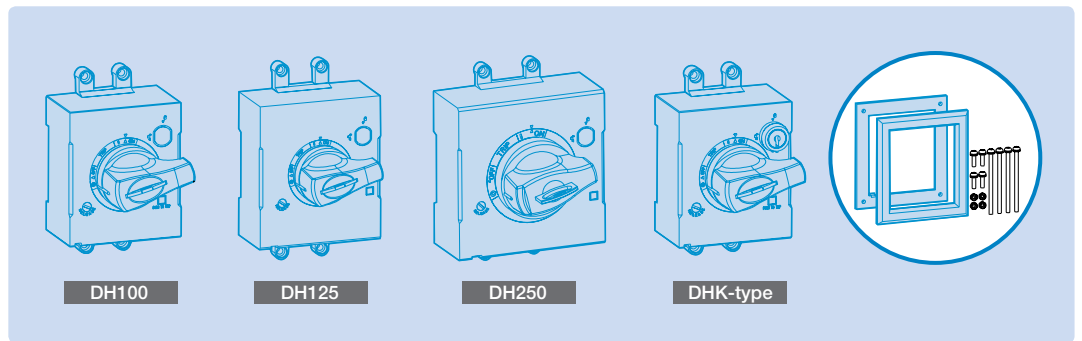
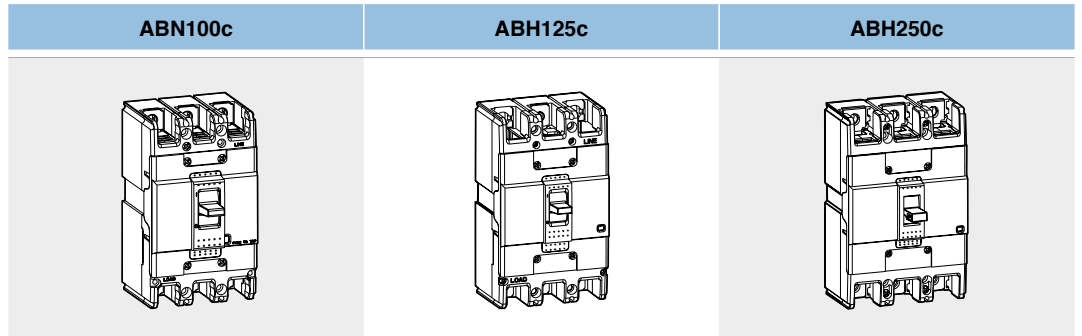

Tripping MCCB & install type

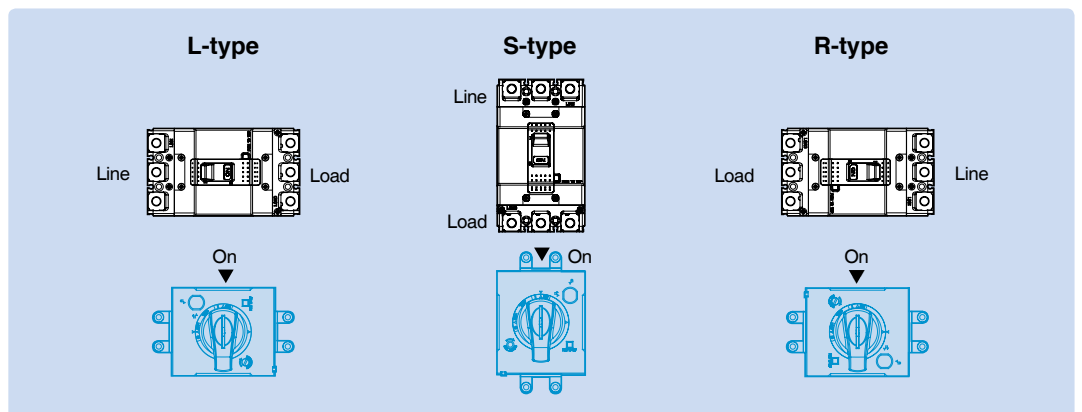
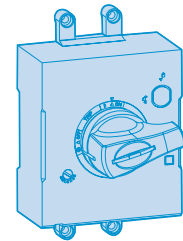
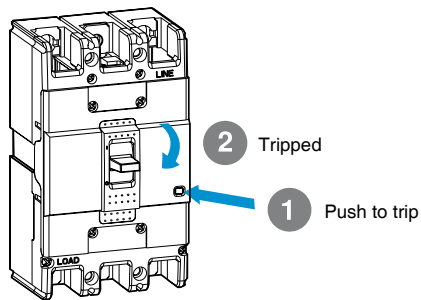

Installing the D-handle

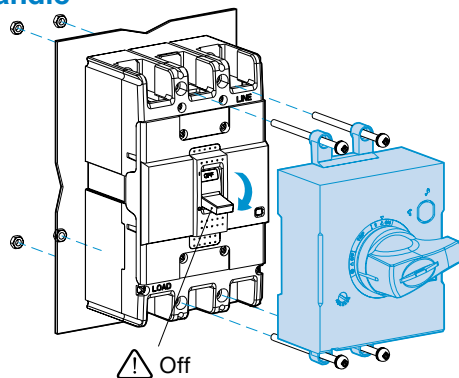

ABN100c, EBN100c	ABH125c, EBH125c	ABH250c, EBH250c

Cutting panel

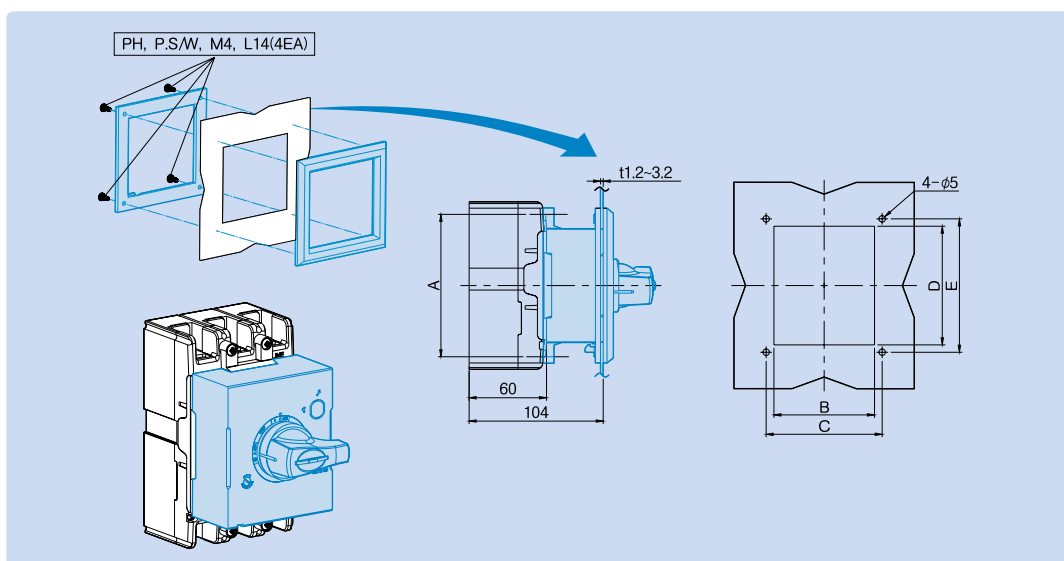

Direct type	A (mm)	B (mm)	C (mm)	D (mm)	E (mm)	Breaker
DH100	110.5	78	90	92	103.4	100AF
DH125	132	94	105	108	120	125AF
DH250	126	108	121	110	122	250AF

D-handle

Operating test

CAUTION

If the door is opened with much pressure when the position of handle is On or trip, the handle lock lever will be damaged.

Trip position: Panel door can't be opened

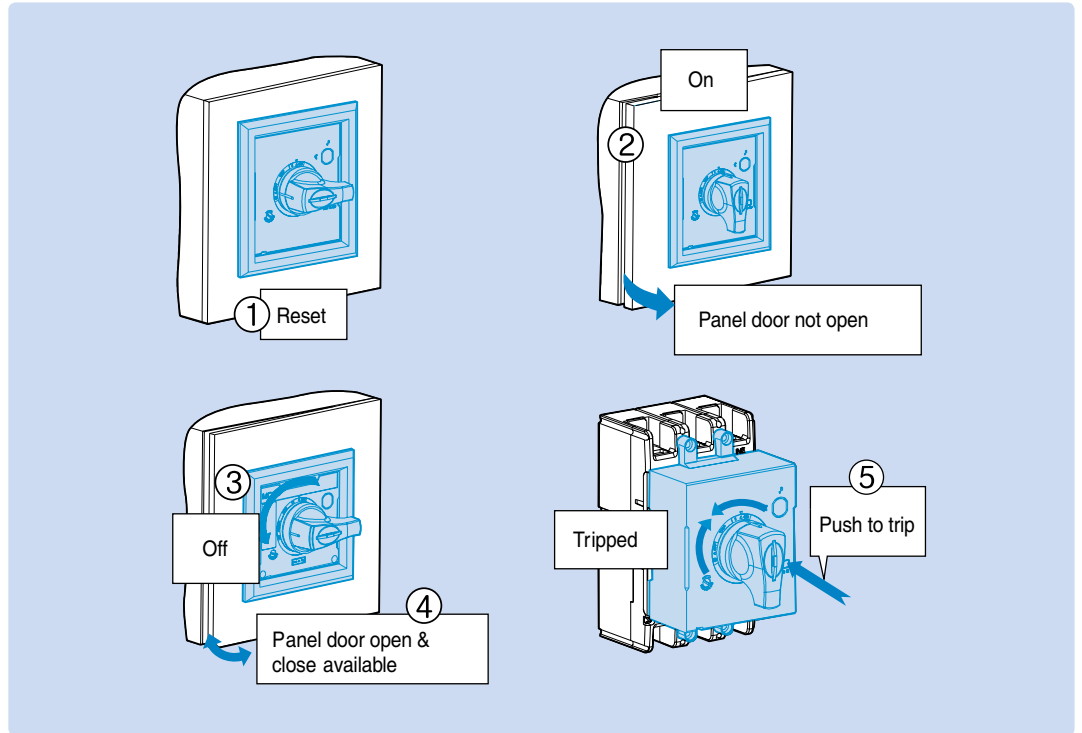

Locking system

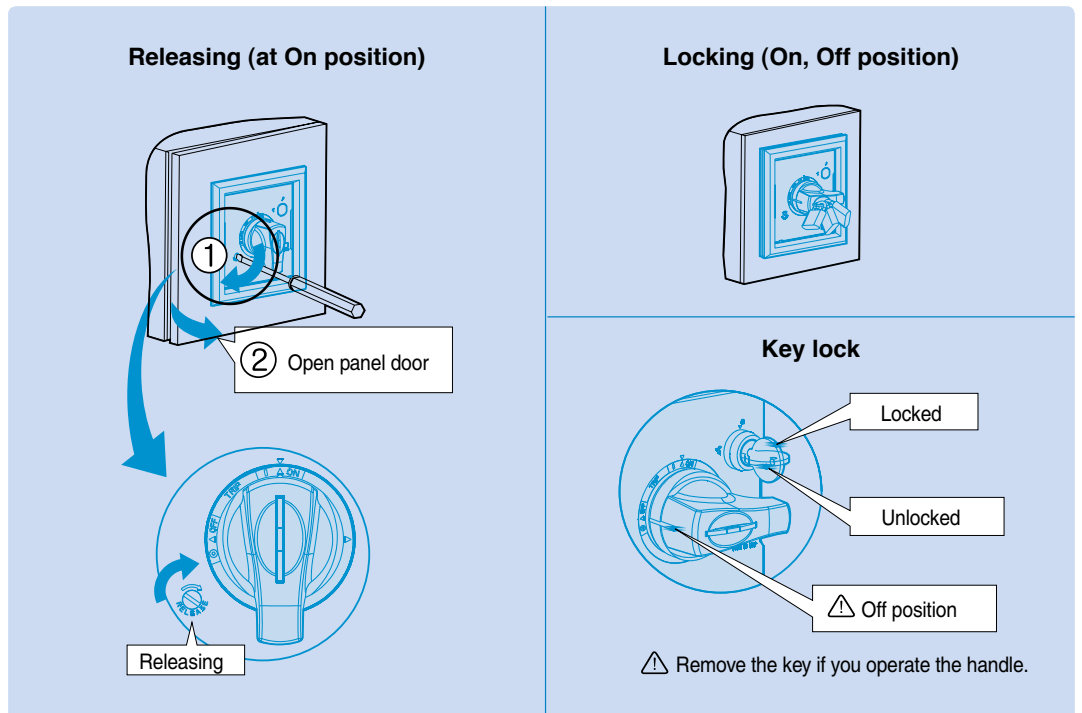

E-handle

MCCB and E-handle

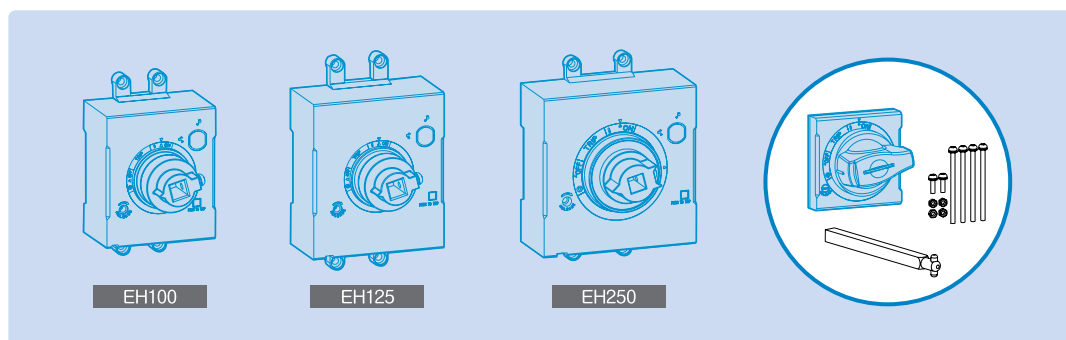
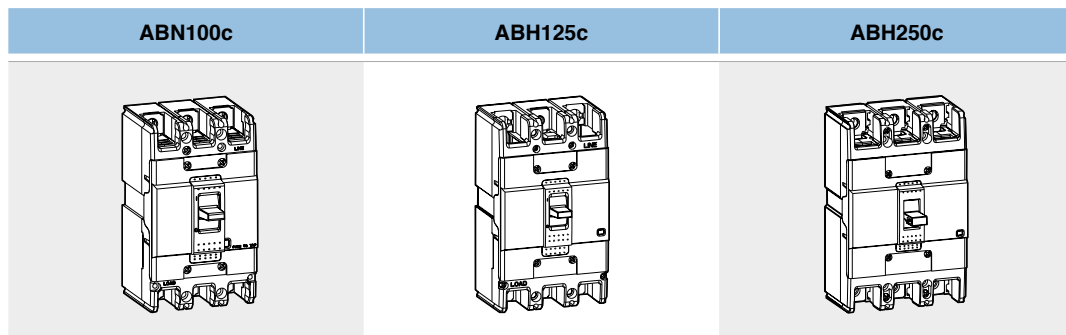

Tripping MCCB & install type

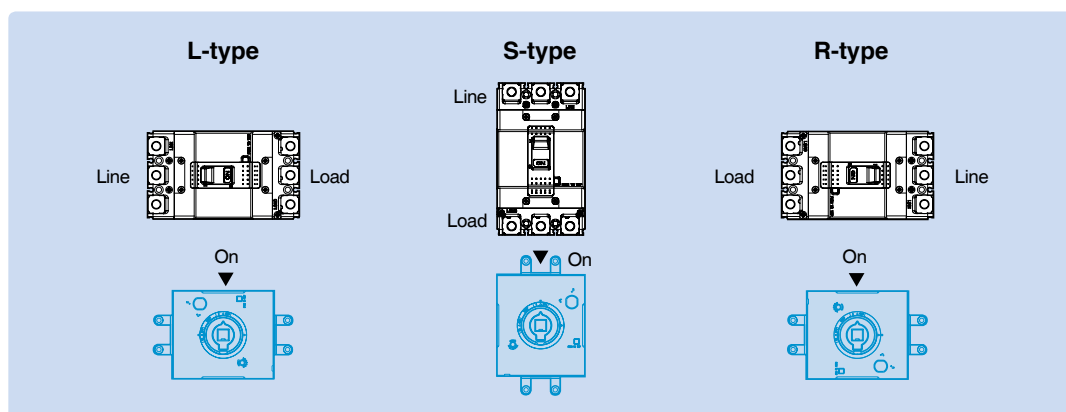
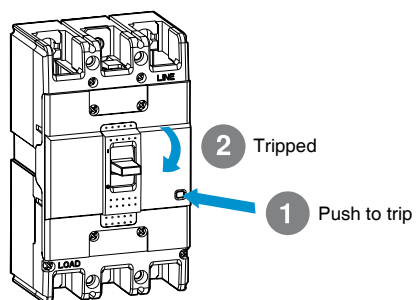

E-handle

Installing the E-handle

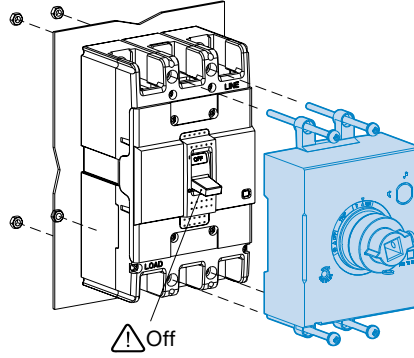

ABN100c, EBN100c	ABH125c, EBH125c	ABH250c, EBH250c

Cutting panel

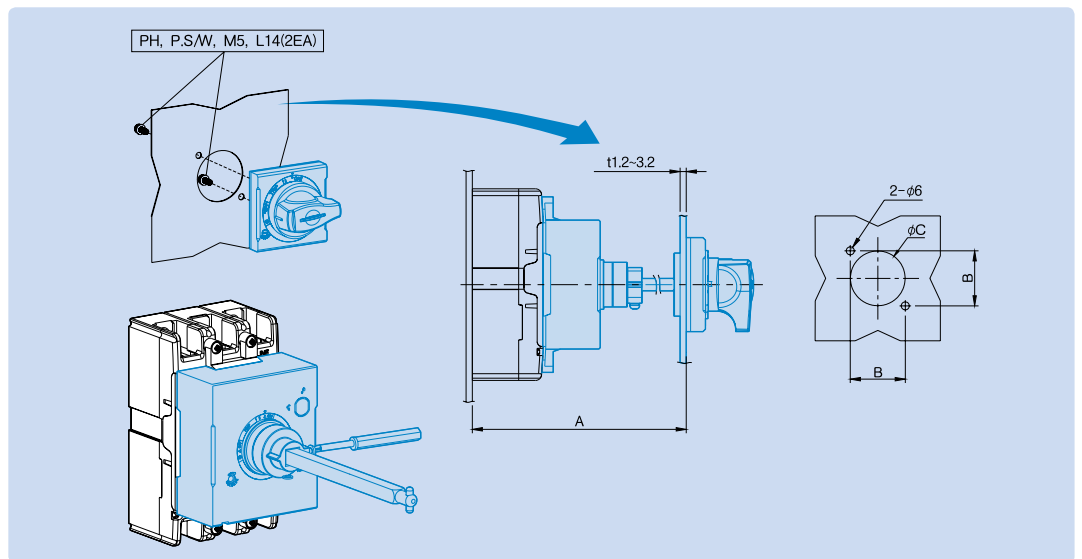

E-handle	A (mm)	B (mm)	C (mm)	Breaker
EH100	min 150, max 573.5 (Shaft469mm)	47	∅53	100AF
EH125	min 150, max 573.5 (Shaft469mm)	47	∅53	125AF
EH250	min 150, max 571.5 (Shaft469mm)	47	∅53	250AF

Note: An extension shaft that must be adjusted to the distance between back of circuit breaker and door

Operating test

CAUTION

If the door is opened with much pressure when the position of handle is On or trip, the handle lock lever will be damaged.

Trip position: Panel door can't be opened

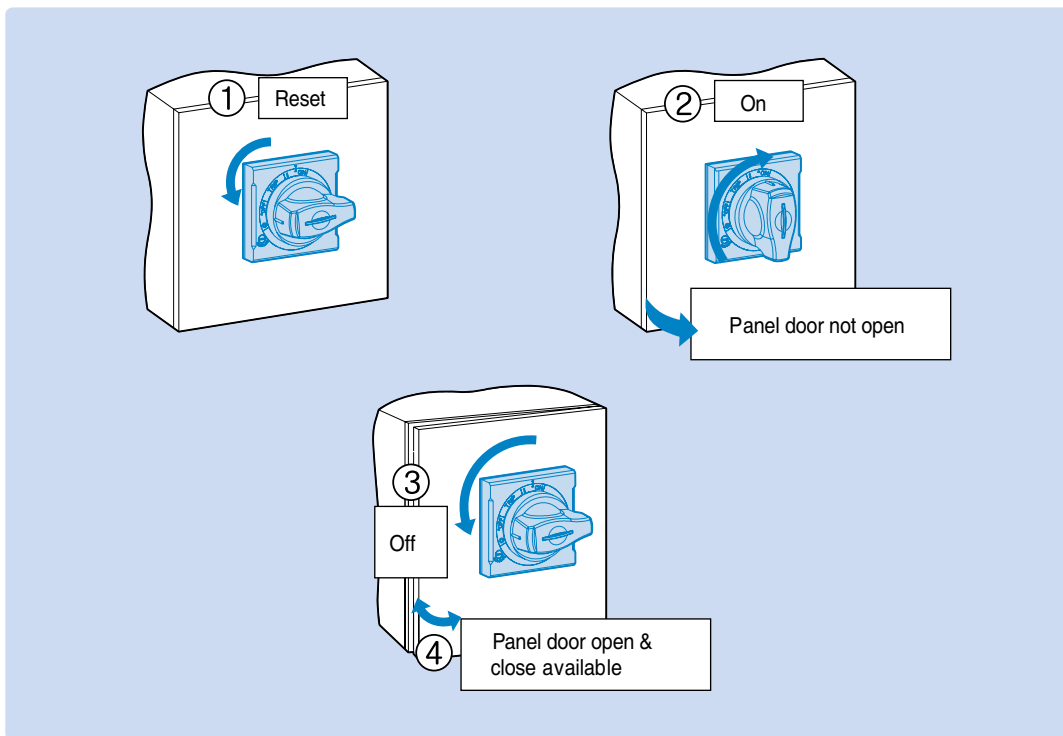

Locking system

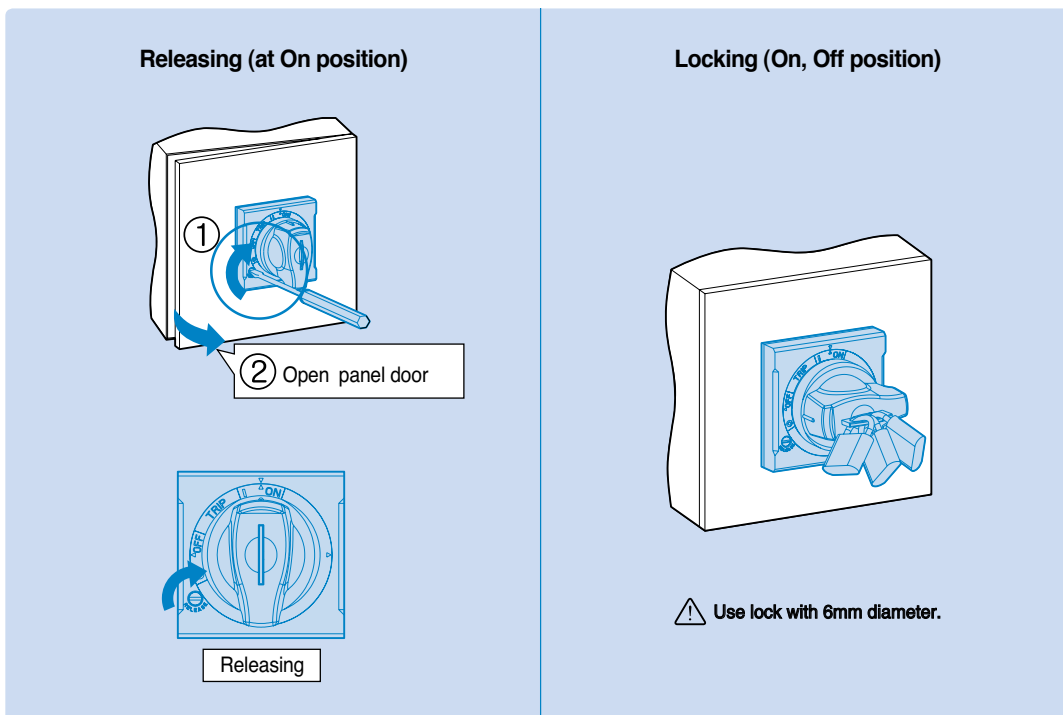

Note : In case of EH100/125/250 Semi Type, it is possible to lock E-handle only in the condition of OFF.

N-handle

How to mount

1) Drilling on the panel door

- ① All the N handles require the same size of mounting hole.
- ② Drill the holes according to the Fig. 1

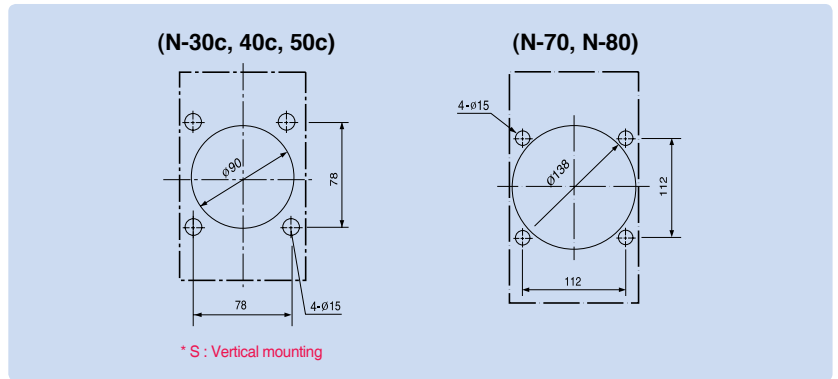

<Fig 1>

(2) Mounting base

- ① Prepare a mounting base according to the Fig. 2. The distance between the door panel and the mounting base should be A+2. Dimension A is shown in the Fig.
- ② In the case of horizontal mounting turn the breaker mounting holes by 90 degrees

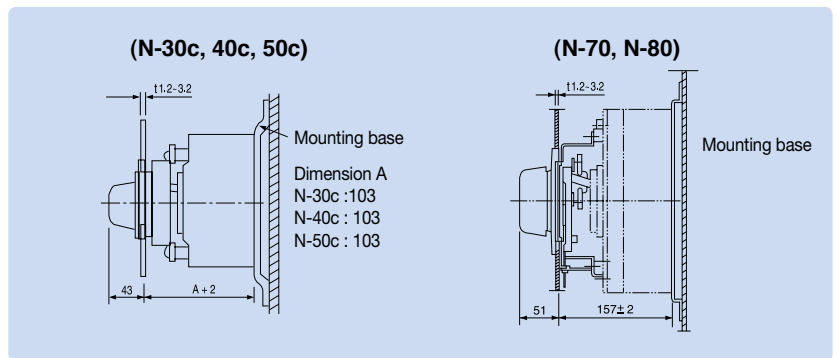

<Fig 2>

(3) Fixing

- ① Fixing a breaker and a handle at the same time.
 - a) As shown in the Fig. 3 a breaker and a handle can be fixed at the same time on a mounting base with the 4 (long) screws enclosed.

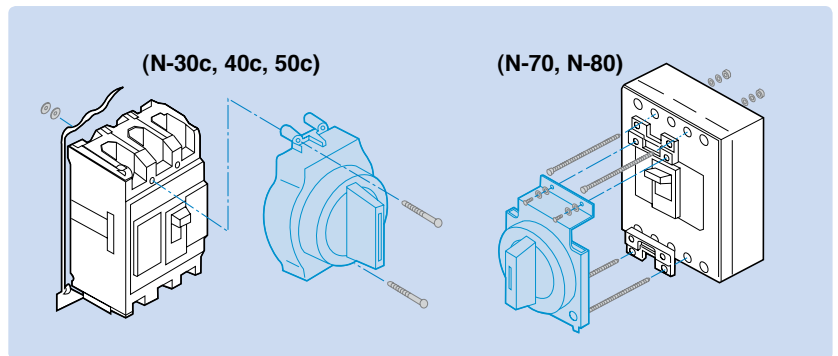

<Fig 3>

- b) Have the breaker handle and the lever of N handle be located in the position shown in Fig. 4.

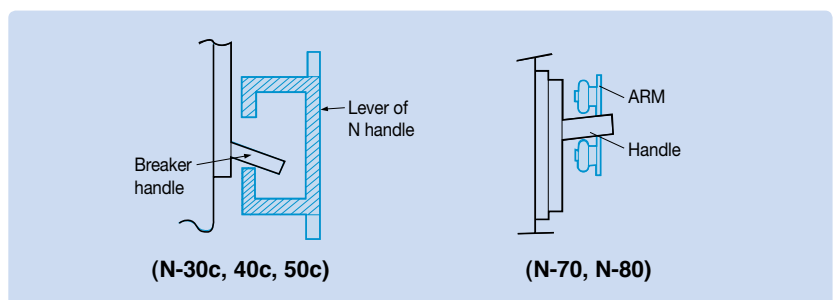

<Fig 4>

- ② Fixing a handle and a breaker step by step
- Check if there is any thin membrane in the mounting hole of the breaker cover and remove it, If exists.
 - Have the breaker handle and the lever of N handle be located in the position shown in Fig. 4.
 - Fix the N handle on the breaker with the 2 (Short) screws enclosed.
 - Fix the breaker on a mounting base with the 2 (Long) screws

(4) Fixing front plate and lock plate

- ① Set the front plate and the locking plate on the door as shown in Fig. 6 fix them with screws.

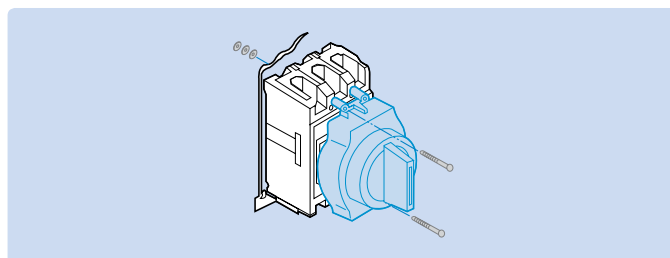

<Fig 5>

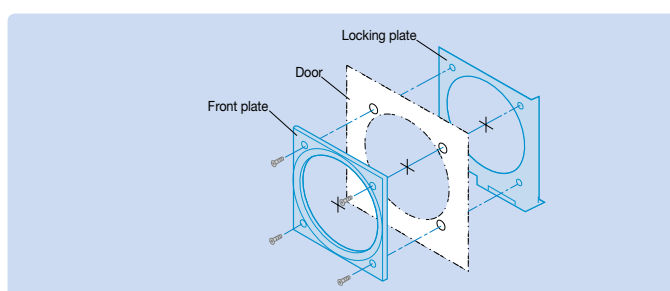

<Fig 6>

- ② Adjust if front plate or handle is at tilt against the breaker .

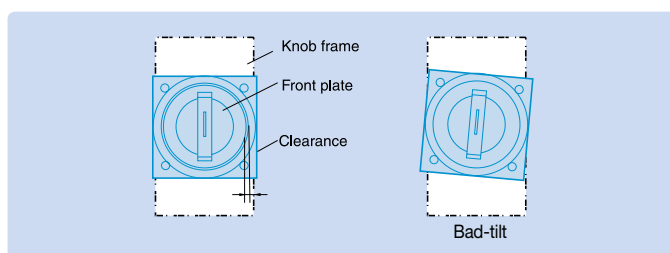

<Fig 7>

- ③ Verify that locking plate and locking lever interact on each other properly when the panel door is closed.
If necessary adjust them by following instructions.

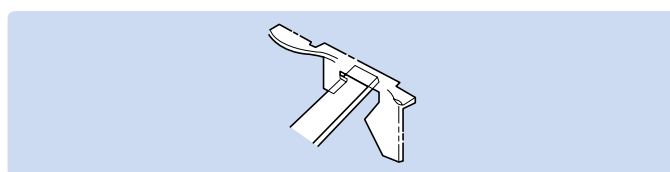

<Fig 8>

- a) In the event the panel door is not fully closed
This happens if the distance between the door panel and the mounting base the panels of the door is short.
Loosen the adjusting screw in the lock plate and move the plate in the direction of the arrow as shown in Fig. 9.

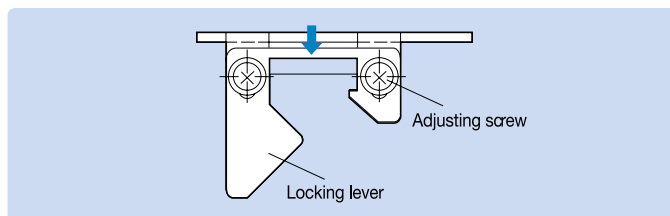

<Fig 9>

- b) In the event the door does not lock after closing the door
This happens if the distance between the door panel and the mounting base the panels of the door is long.
Loosen the adjusting screw in the lock plate and move the plate in the direction of the arrow as shown in Fig. 10.

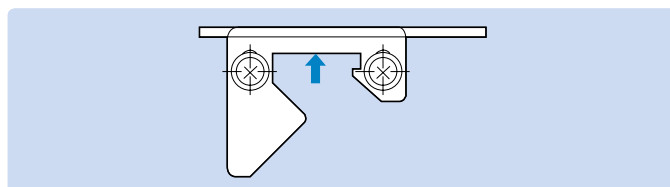

<Fig 10>

N-handle

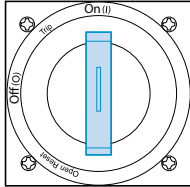

<Fig 11>

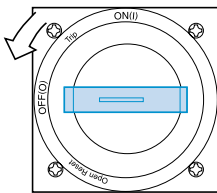

<Fig 12>

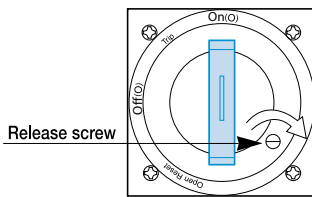

<Fig 13>

(1) Operation in the door closed

- ① To have the breaker On turn the handle to be vertical. <Fig. 11>
- ② To have the breaker Off turn the handle to be horizontal. <Fig. 12>
- ③ If the breaker is tripped, the handle points to the Trip position.
- ④ To reset the breaker turn the handle to Reset position.

(2) Unlocking the panel door

- ① The door is locked and will not open at On, Off and Trip status.
- ② To unlock the door from Off or Trip status turn the handle toward OPEN direction. (Unlocked after taking the hand off the handle.)
- ③ To unlock the door from on state turn the Release screw clockwise <Fig. 13>

(3) Operation of the breaker in the door open

- ① When the door is open the breaker will not be on as the lock lever operates.
- ② To release the locking pull the lock lever to be nearly horizontal position. Then the breaker can be closed. <Fig. 14>
- ③ If the door is closed the lock lever will be reset automatically.

(N-30, 40, 50)

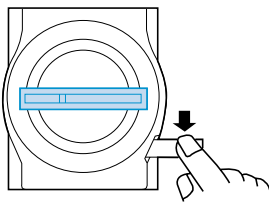

(N-70, N-80)

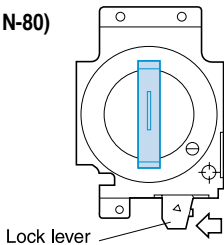

<Fig 14>

Padlocking

- ① Lockable at On or Off state with a padlock. (Padlock is not supplied)
- Lockable at Off state with a padlock is an optional spec.
- ② Pull the lock plate on the front of the handle and fasten the lock. <Fig. 15>
- ③ If the breaker is tripped after padlocking at on state, the handle will point to the trip.
- ④ Padlock diameter should be 3.5 ~ 6mm

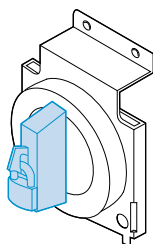

<Fig 15>

Dimensions for N-handle hinges

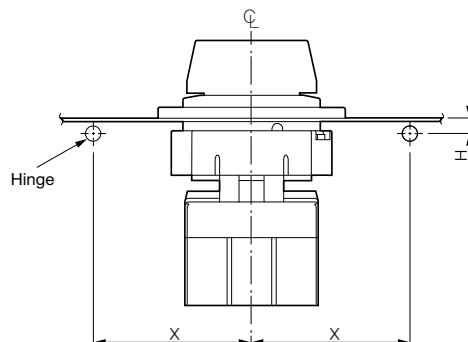

Unit: mm

Handle types	Hinge dimensions	
	H	X
N-30c N-40c N-50c	0 or more	5H + 110 or more
N-70 N-80	0 or more	5H + 100 or more

Terminal covers

The terminal covers are applied to the circuit-breaker to prevent accidental contact with live parts and thereby guarantee protection against direct contacts.

Two types by length are available and provide IP20 degree of protection.

Also, covers are classified into 2 different types: Independent, Attachable and detachable with D or N handle

- **Short type covers, TCS:**

For fixed circuit-breakers with rear terminals and for moving parts of plug-in.

- **Long type covers, TCL:**

For fixed circuit-breakers with front, front extended, front for cables terminals.

Terminal covers						Pole	Applied breaker		Size extended (A), mm	
Short type			Long type				MCCB	ELCB	Short type	Long type
Inde	D-handle	N-handle	Inde	D-handle	N-handle					
TBS22	-	-	-	-	-	2P	ABE30b	-	10	-
TBS23	-	-	-	-	-	3P				
TCS12	-	-	TCL12	-	-	2P	ABN50c/60c/100c/100e	EBN50c/60c/100c	5.5	30
TCS/T-12	-	-	TCL/T-12	-	-					
TCS13	TCS13	TCS13	TCL13	TCL13	TCL13	3P	ABS30c/50c/60c	EBS30c/50c/60c	5.5	30
TCS/T-13	TCS/T-13	TCS/T-13	TCL/T-13	TCL/T-13	TCL/T-13					
TCS14	TCS14	TCS14	TCL14	TCS14	TCS14	4P	ABS125c	EBS125c	5.5	40
TCS/T-14	TCS/T-14	TCS/T-14	TCL/T-14	TCL/T-14	TCL/T-14					
TCS22	-	-	TCL22	-	-	2P	ABH50c/125c	EBH50c/125c	5.5	40
TCS/T-22	-	-	TCL/T-22	-	-					
TCS23	TCS23	TCS23	TCL23	TCL23	TCL23	3P	ABL125c	EBS250c	5.5	50
TCS/T-23	TCS/T-23	TCS/T-23	TCL/T-23	TCL/T-23	TCL/T-23					
TCS24	TCS24	TCS24	TCL24	TCL24	TCL24	4P	ABN250c, ABS250c	EBN250c,	5.5	50
TCS/T-24	TCS/T-24	TCS/T-24	TCL/T-24	TCL/T-24	TCL/T-24					
TCS33	TCS33	TCS33	TCL33	TCL33	TCL33	2, 3P	ABH250c, ABL250c	EBS250c	5.5	50
TCS/T-33	TCS/T-33	TCS/T-33	TCL/T-33	TCL/T-33	TCL/T-33					
TCS34	TCS34	TCS34	TCL34	TCL34	TCL34	4P	EBN250c,	EBS250c	5.5	50
TCS/T-34	TCS/T-34	TCS/T-34	TCL/T-34	TCL/T-34	TCL/T-34					
-	-	-	T1-43A	-	-	2, 3P	ABN/S/H/L400c	EBN/S/H/L400c	-	120
-	-	-	T1-44A	-	-	4P				
-	-	-	T1-63A	-	-	2, 3P	ABN/S/L630c/800c	EBN/S/L630c/800c	-	141
-	-	-	T1-63A	-	-	4P				

Note: Terminal covers for 400AF and 800AF MCCBs are in acrylic.

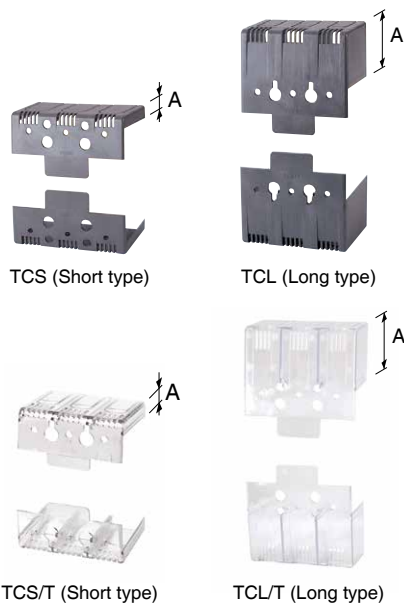

Insulation barriers



Insulation barrier allows the insulation characteristics between the phases at the connections to be increased. They are mounted from the front, even with the circuit-breaker already installed, inserting them into the corresponding slots.

They are incompatible with both the insulating terminal covers.

It is possible to mount the phase separating partitions between two circuit-breakers side by side.

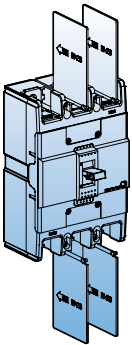

Type	Breaker	
	MCCB	ELCB
IB-13	ABN50c/60c/100c/100e ABS30c/50c/60c	EBN50c/60c/100c EBS30c/50c/60c
IB-23	ABS125c ABH50c/125c ABN250c, ABS250c ABH250c ABL125c, ABL250c	EBS125c EBH50c/125c EBN250c, EBS250c EBH250c
IBL400	ABN/S/H/L400c	EBN/S/H/L400c
IBL800	ABN/S/L800c	EBN/S/L800c



Insulation barriers for line side are provided as standard.

Rear connection terminals

Rear connection terminals are used to adapt the circuit breakers to switchboards or other applications that require rear connection. There are two kinds of rear connection terminals.

- Flat type
- Round type

Round type terminals

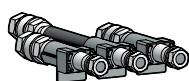

Breaker	For 2-pole	For 3-pole	For 4-pole
ABN100c 50AF	RTR1-52	RTR1-53	-
ABN100c 100AF	RTR1-102	RTR1-103	RTR1-104
ABH125c	RTR2-102	RTR2-103	RTR2-104
ABH250c	RTR3-202	RTR3-203	RTR3-204

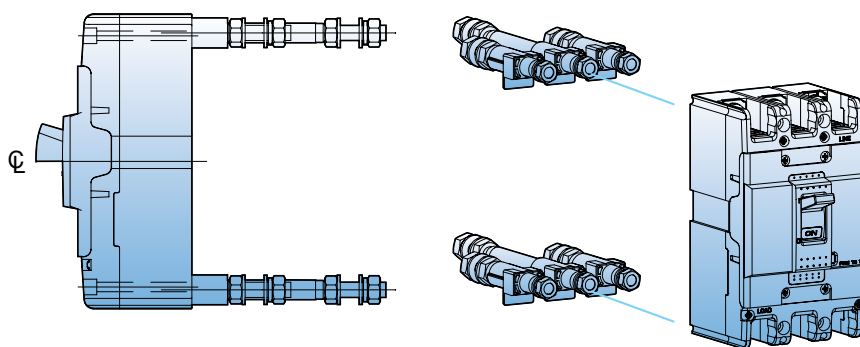

Flat type terminals



Breaker	For 2-pole	For 3-pole	For 4-pole
ABN100c	RTB1-102	RTB1-103	RTB1-104
ABH125c	RTB2-102	RTB2-103	RTB2-104
ABH250c	RTB3-202	RTB3-203	RTB3-204

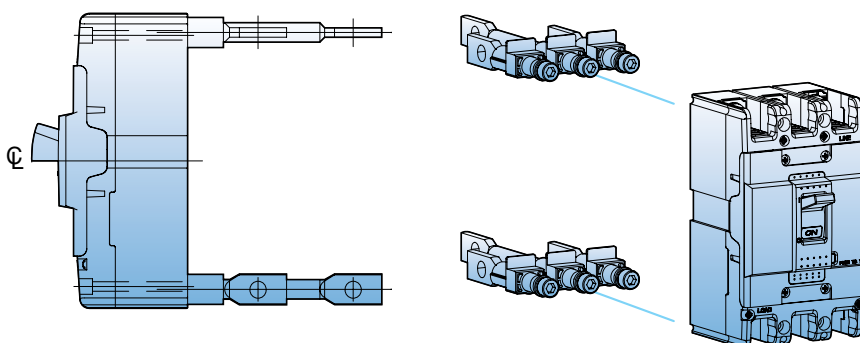

Mechanical interlock

The mechanical interlock is installed on the front of two breakers mounted side by side, in either the 3-pole or 4-pole version and prevents simultaneous closing of the two breakers. So it is suitable for consisting of manual sourcechangeover system.

Type numbering system

MI	—	4	3														
Type		AF	Pole														
Mechanical interlock		<table border="1"> <tr><td>1</td><td>100AF</td></tr> <tr><td>2</td><td>125AF</td></tr> <tr><td>3</td><td>250AF</td></tr> <tr><td>4</td><td>400AF</td></tr> <tr><td>8</td><td>800AF</td></tr> </table>	1	100AF	2	125AF	3	250AF	4	400AF	8	800AF	<table border="1"> <tr><td>3</td><td>3P</td></tr> <tr><td>4</td><td>4P</td></tr> </table>	3	3P	4	4P
1	100AF																
2	125AF																
3	250AF																
4	400AF																
8	800AF																
3	3P																
4	4P																

Types and applicable breakers

Type	MCCB	ELCB
MI-13, 14	ABS30c, ABS50c, ABS60c, ABN50c, ABN60c, ABN100c, ABN100e	EBS30c, EBS50c, EBS60c, EBN50c, EBN60c, EBN100c
MI-23, 24	ABS125c, ABH50c, ABH125c, ABL125c	EBS125c, EBH50c, EBH125c
MI-33, 34	ABN/S/H/L250c	EBN/S/H250c
MI-43, 44	ABN/S/H/L400c	EBN/S/H/L400c
MI-83, 84	ABN/S/L800c	EBN/S/L800c

Note) MI is not applicable to 2-pole version breakers of 100AF and 125AF.

Layout

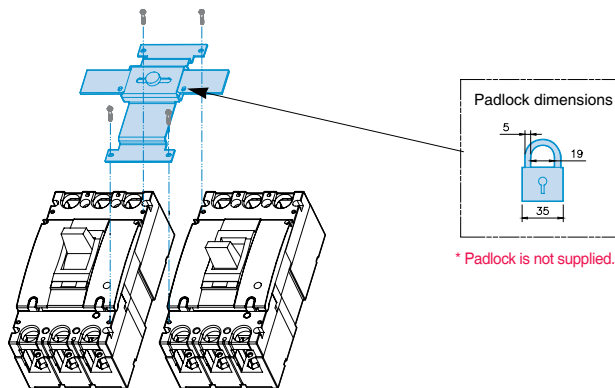

MCCB panel cutting

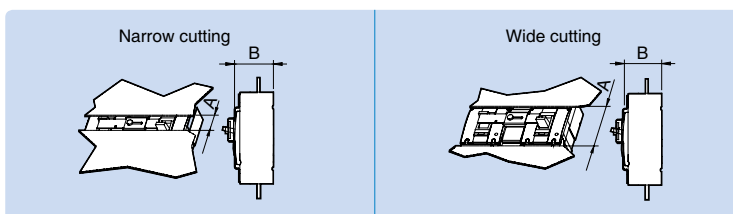

(Unit in: mm)

Cutting	MI-13, 14		MI-23, 24		MI-33, 34		MI-43, 44		MI-83, 84	
	A	B	A	B	A	B	A	B	A	B
Narrow	52	66	52	66	52	66	100	111	100	111
Wide	86	62	102	62	104	62	152	97	152	97

MCCB panel drilling

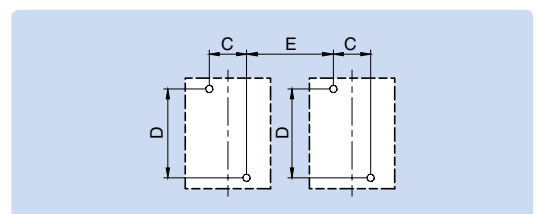

(Unit in: mm)

Breaker	C		D		E	
	3P	4P	3P	4P	3P	4P
100AF	25	25	110.5	110.5	70	95
125AF	30	30	132	132	84	114
250AF	35	35	126	126	99	134
400AF	44	44	215	215	166	210
800AF	70	70	243	243	210	280

Plug-in devices



Plug-in base

Plug-in device makes it possible to extract and/or rapidly replace the circuit breaker without having to touch connections for ship and important installations.

The plug-in base is the fixed part of the plug-in version of the circuit-breaker.

It will be installed directly on the back plate of panel.

The circuit-breaker is racked out by unscrewing the top and bottom fixing screws.

Normal type plug-in MCCB

- MCCB current rating upto 250A
- Generally used in switchgears

Double-row type plug-in MCCB

- For 125AF MCCB
- Generally used in branch circuits

Type names of blocks

Breaker	Arrangement	Plug-in block	Remark
ABN100c	Normal	PB-A3-FR	
	Single-row	PB-A3-1DB	
	Double-row	PB-A3-2DB	
	Line-only	PB-A3-FRL	
ABH125c	Normal	PB-C3-FR	
	Single-row	PB-C3-1DB	
	Double-row	PB-C3-2DB	
ABH250c	Normal	PB-D3-FR	
400AF	Normal/Line-only	PB-I3-FR/PB-I3-FRL	
800AF	Normal	PB-J3-FR	

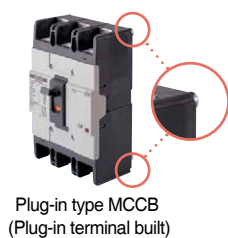

Plug-in type MCCB
(Plug-in terminal built)



ABH103c plug-in type



ABH203c plug-in type

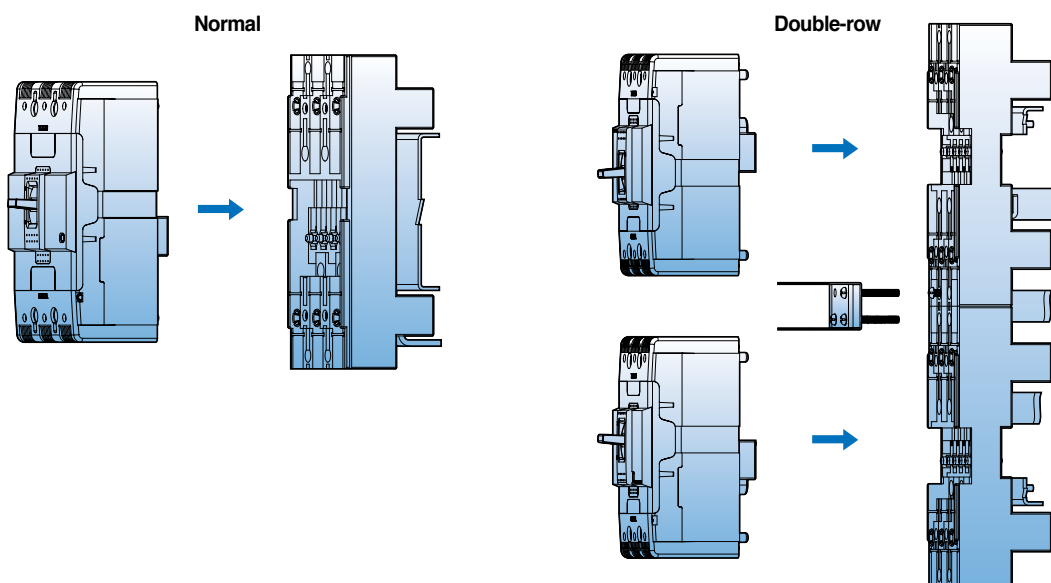

Remote operation

Motor operator

Motor operators can also be operated by manual. The motor drives a mechanism which switches TD & TS toggle handle to the "On" and "Off/Reset" positions.

- The manual actuator handle is located on the front of the cover.
- Manual or Automatic operation can be selected.
- Applicable to 2, 3 and 4-pole breakers.



MCCB			Type	Control voltage	Actuation current (A)	Response time (ms)		Mechanical service life (operations)	No. of operations per hour
2P	3P	4P				Closing	Opening		
-	ABN53c, ABN63c, ABN103c, ABN103e, ABS33c, ABS53c, ABS63c	ABN54c, ABN64c, ABN104c, ABN104e, ABS34c, ABS54c, ABS64c	MOP-M1	① DC24V ② AC110V~DC110V ③ AC230V/DC220V	≤3A (DC24V) ≤0.5A (AC)	700	700	10,000	120
-	ABS103c, ABH53c, ABH103c, ABL103c	ABS104c, ABH54c, ABH104c, ABL104c	MOP-M2	① DC24V ② AC110V~DC110V ③ AC230V/DC220V	≤3A (DC24V) ≤0.5A (AC)	840	840	10,000	120
ABN202c, ABS202c, ABH202c, ABL202c	ABN203c, ABS203c, ABH203c, ABL203c	ABN204c, ABS204c, ABH204c, ABL204c	MOP-M3	① DC24V ② AC110V~DC110V ③ AC230V/DC220V	≤3A (DC24V) ≤0.5A (AC)	840	840	10,000	120
ABN402c, ABS402c, ABH402c, ABL402c	ABN403c, ABS403c, ABH403c, ABL403c	ABN404c, ABS404c, ABH404c, ABL404c	MOP-M4	① DC24V ② AC110~DC110V ③ AC230V/DC220V	≤6A (DC24V) ≤0.8A (AC)	1,200	1,200	4,000	60
ABN802c, ABS802c, ABL802c	ABN803c, ABS803c, ABL803c	ABN804c, ABS804c, ABL804c	MOP-M5	① DC24V ② AC110~DC110V ③ AC230V/DC220V	≤6A (DC24V) ≤0.8A (AC)	1,200	1,200	2,500	60
-	ABS1003b, ABS1203b, ABL1003b, ABL1203b	ABS1004b, ABS1204b, ABL1004b, ABL1204b	MOP-M6	① AC230V/DC220V	≤6A (DC24V) ≤0.8A (AC)	1,500	1,500	2,500	20

Wiring connection

Standard connection

- 1) Remote On and Off of MCCB and manual operation
- 2) Be careful not to change the polarity at DC24V

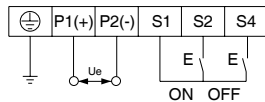

Connection with alarm switch (AL)

- 1) The connection diagram is the method of using a alarm switch (AL) without shunt or undervoltage trip. A trip due to a fault or trip button prevent a remote reset.
- 2) The fault must be cleared surely and reset it with manual operation.

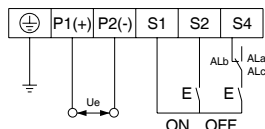

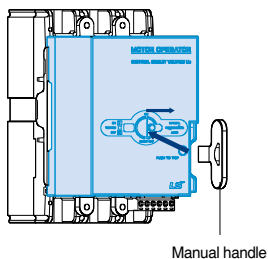

Manual operation

- 1) Insert the manual handle into the slot of Motor operator surface and rotate it clockwise.
- 2) It must be rotated just 180° clockwise for safe operation of micro switch in the motor operator.
- 3) Return the manual handle after the manual operation
- 4) Turn the slide switch back to the position of Auto.

CAUTION: When the circuit breaker is tripped by trip button in the Off status, it is impossible to operate motor operator automatically. It must be reset by manual operation.

Automatic operation

- 1) Set the slide switch to Auto, then internal power is closed automatically.
- 2) Operating frequency should be less than these below regulated values.
MOP-M1~M3, M7 (120 operations per hour) , MOP-M4 (60 operations per hour) ,
MOP-M5, M6 (20 operations per hour)
- 3) Use the On/Off switch in the range of regulated values.
- 4) It may interfere near communication equipments because of internal switching power supply.
It's recommended that a noise filter be installed to power supply.
- 5) Please do not input On/Off signals at the same time during the automatic operation.
- 6) If the circuit breaker has a UVT attached inside, charge a UVT on the rated voltage before performing Motor operator.

Motor operator

Feature

- ① On position indication (Red color)
- ② Trip position indication (White color)
- ③ Off position indication (Green color)
- ④ Button for push to trip
- ⑤ On/Off/Reset selection lever
- ⑥ Manual/Auto selection lever

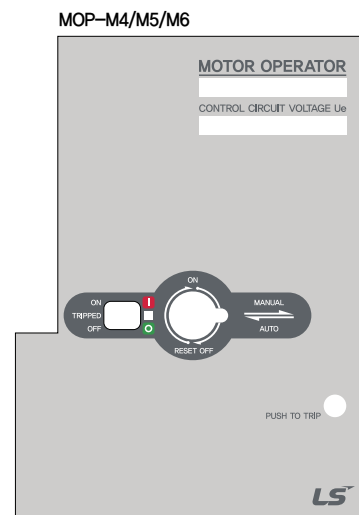
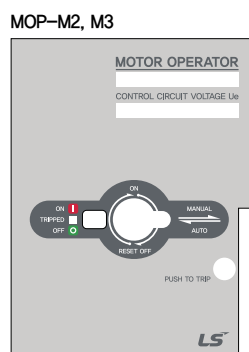
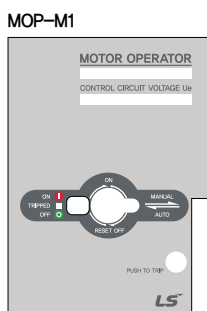
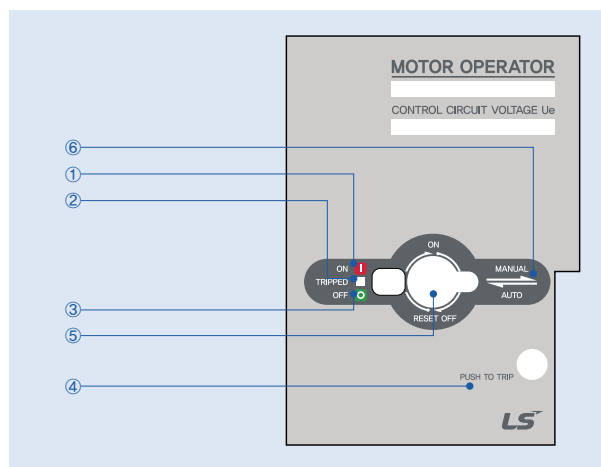

Characteristics curves

Breaker types

MCCB
ABE30b

Compensation curves

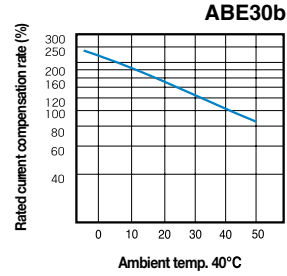

Rated current: 3~30A (ABE)

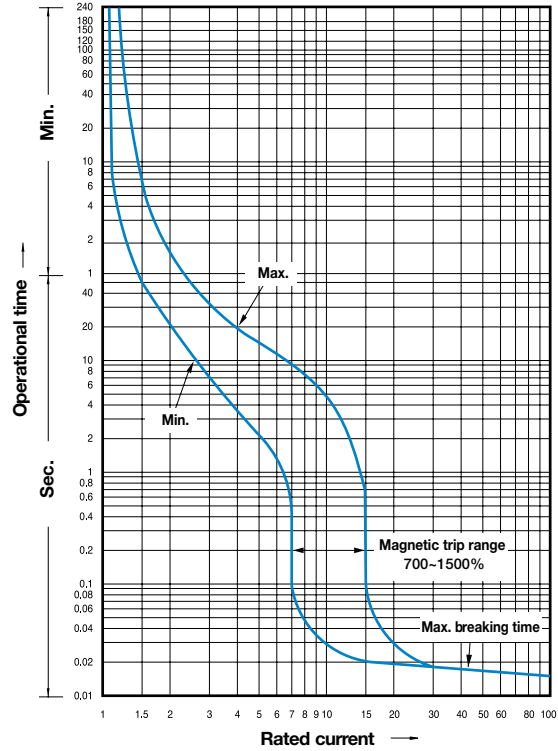

Breaker types

MCCB
ABN50c/60c/100c/100e
ABS30c/50c/60c
ELCB
EBN50c/60c/100c
EBS30c/50c/60c

Compensation curves

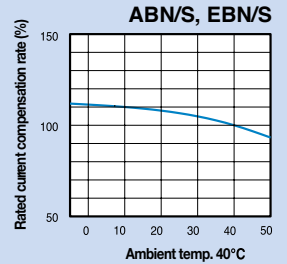

Rated current: 3~30A (ABN/S,EBN/S)

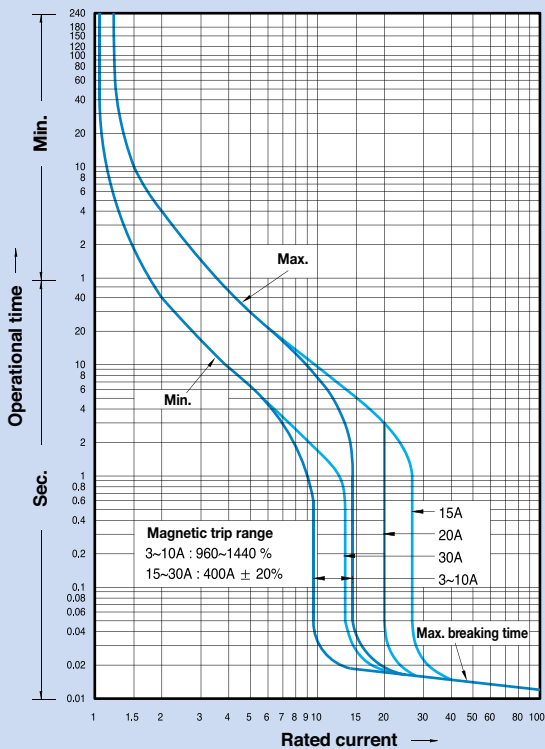

Rated current: 40~100A (ABN/S,EBN/S)

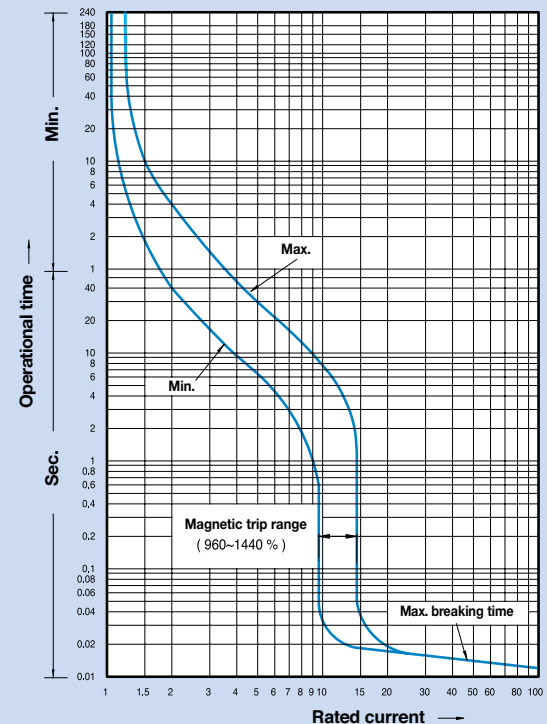

Breaker types

MCCB
ABS125c
ABH50c/125c
ABL125c
ELCB
EBS125c
EBH50c/125c

Rated current: 15~30A, 40~100A

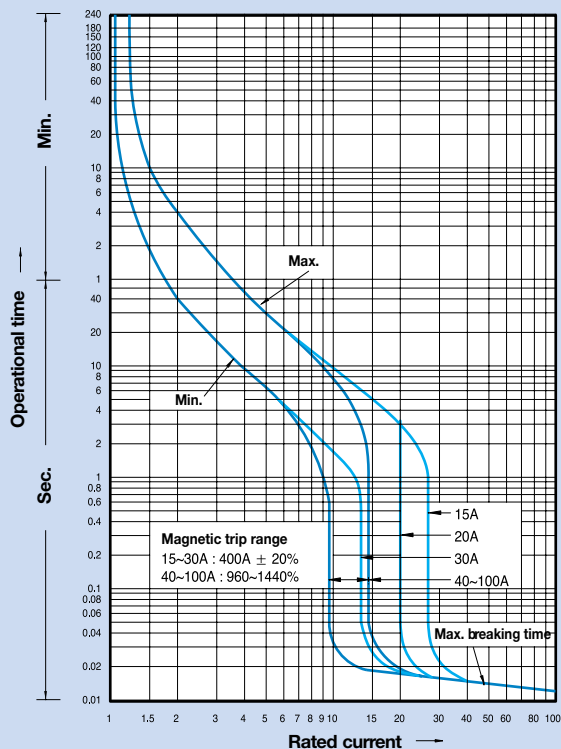

Compensation curves

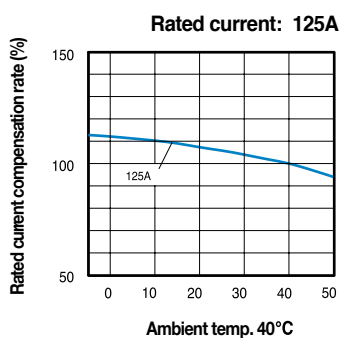
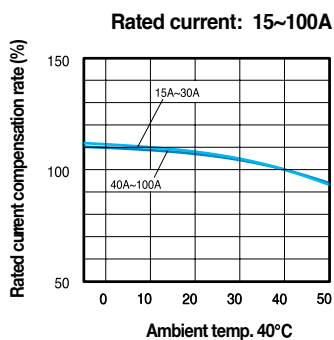

Rated current: 125A

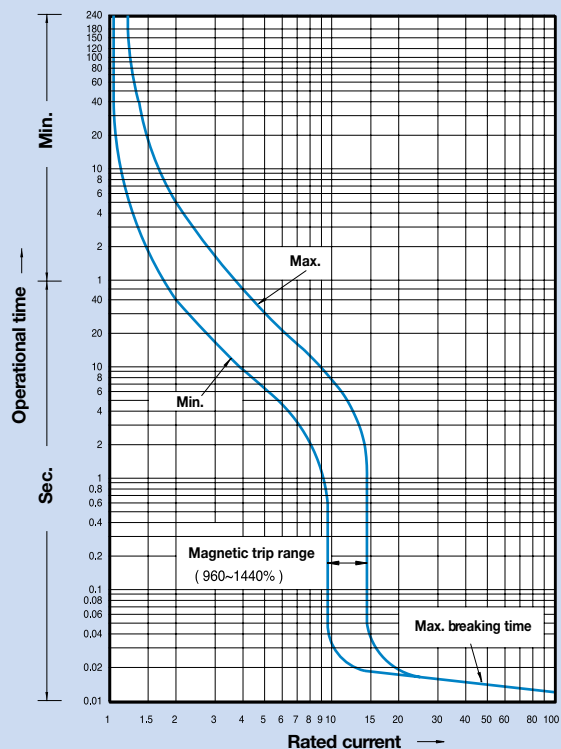

Characteristics curves

Breaker types

MCCB
ABN250c, ABS250c
ABH250c, ABL250c
ELCB
EBN250c, EBS250c
EBH250c

Rated current: 100~225A

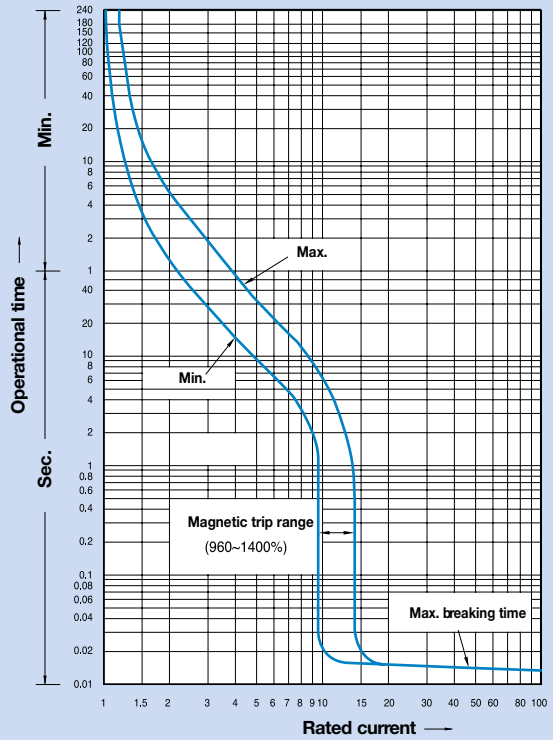

Compensation curves

Rated current: 100~225A

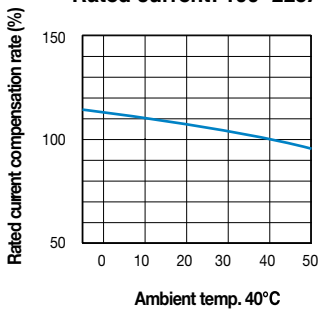

Rated current: 250A

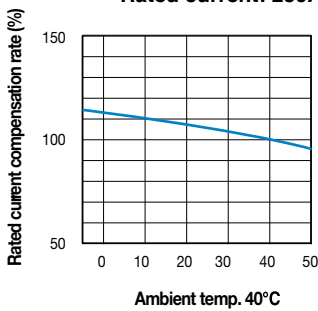

Rated current: 250A

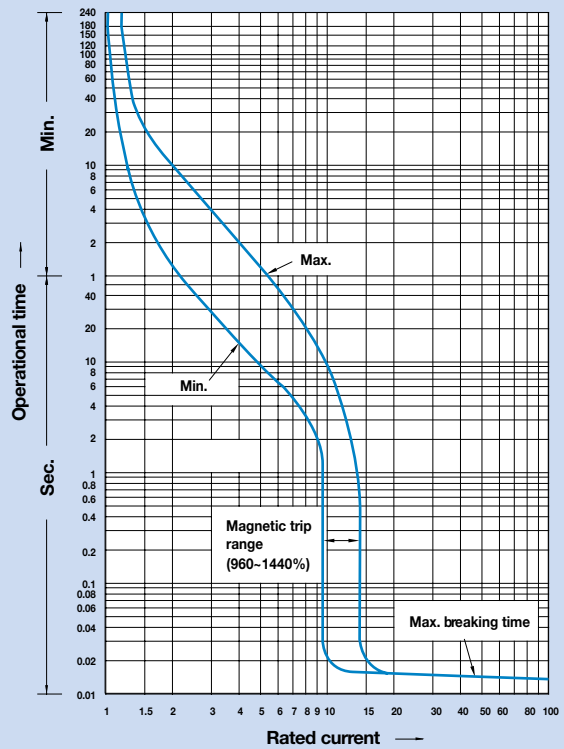

Breaker types

MCCB
ABN400c, ABS400c, ABH400c, ABL400c
ABN800c, ABS800c, ABL800c
ELCB
EBN400c, EBS400c, EBH400c, EBL400c
EBN800c, EBS800c, EBL800c

Rated current: 250~400A

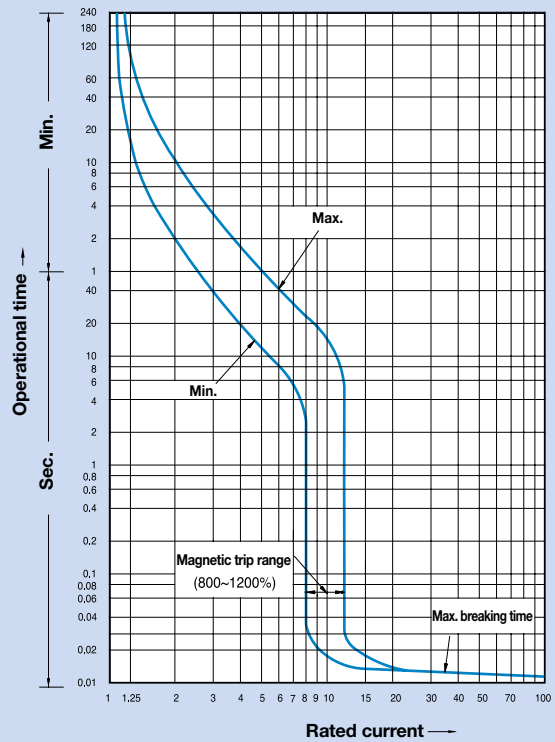

Compensation curves

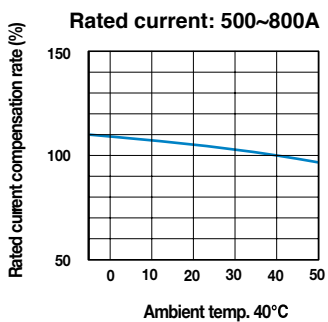
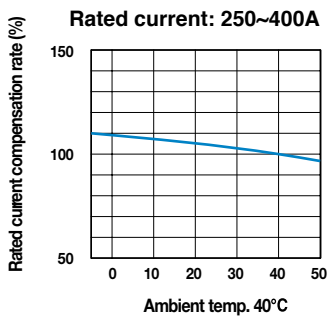

Rated current: 500~800A

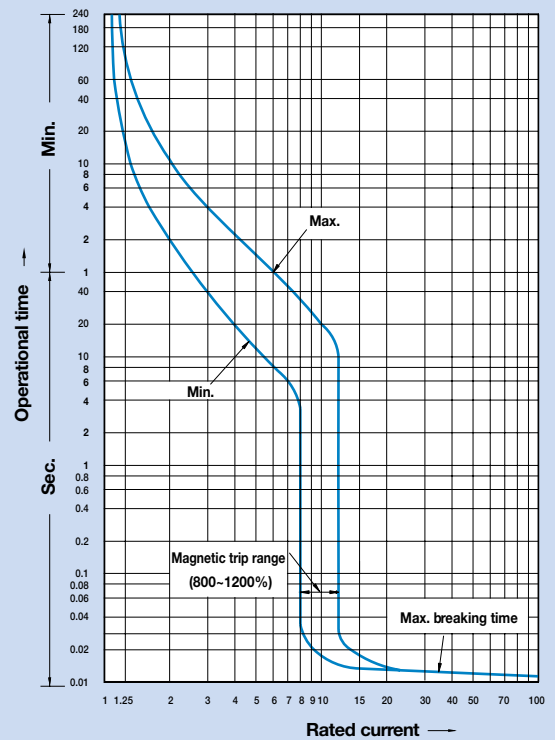

Characteristics curves

Breaker types

MCCB
ABS1000b, ABL1000b
ABS1200b, ABL1200b
ELCB
EBS1003b, EBS1203b

Compensation curves

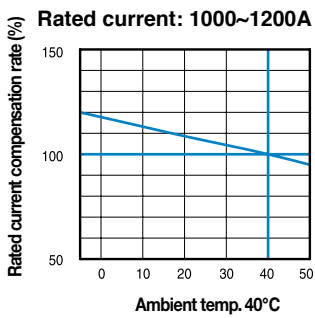

Breaker types

MCCB
ABS1200bE

Rated current: 1000~1200A

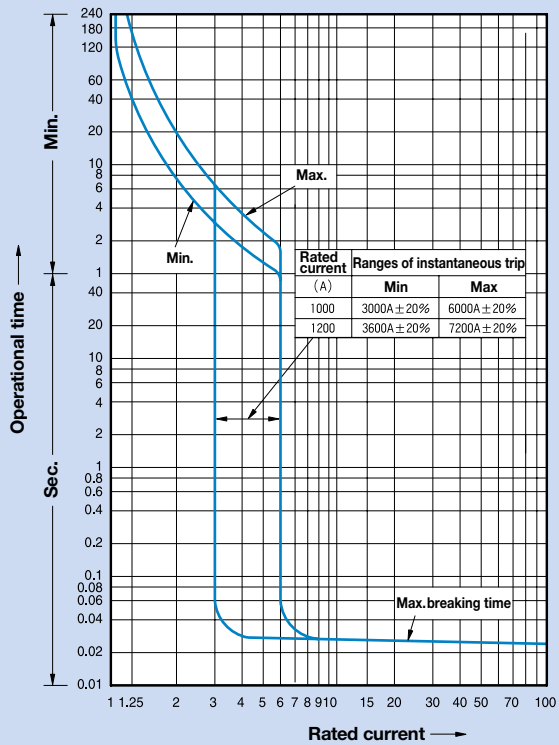

Rated current: 1200A

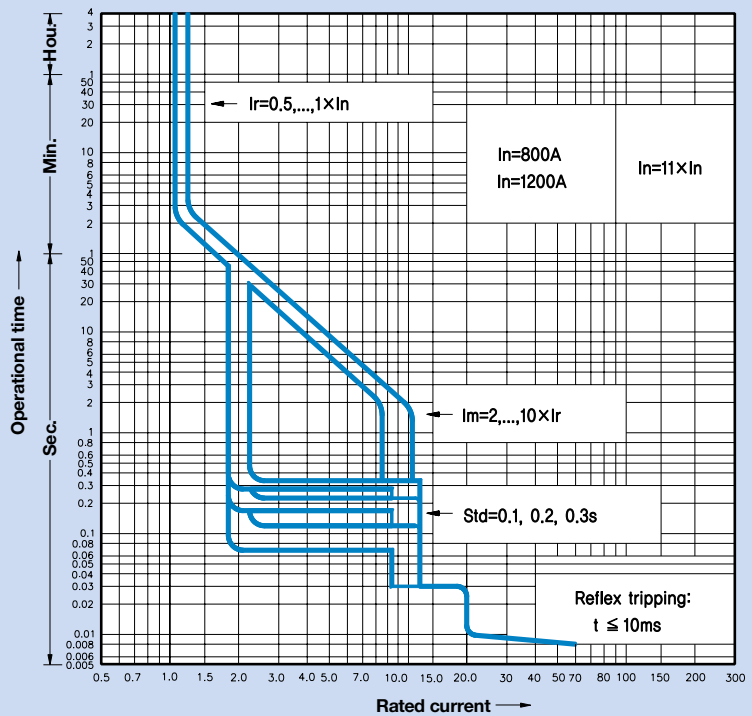

Characteristics curves (Adjustable)

Breaker types

ELCB

EBN 50c/60c/100c/250c

EBS 30c/50c/60c/125c/250c

EBH 50c/125c/250c

1A, 1s

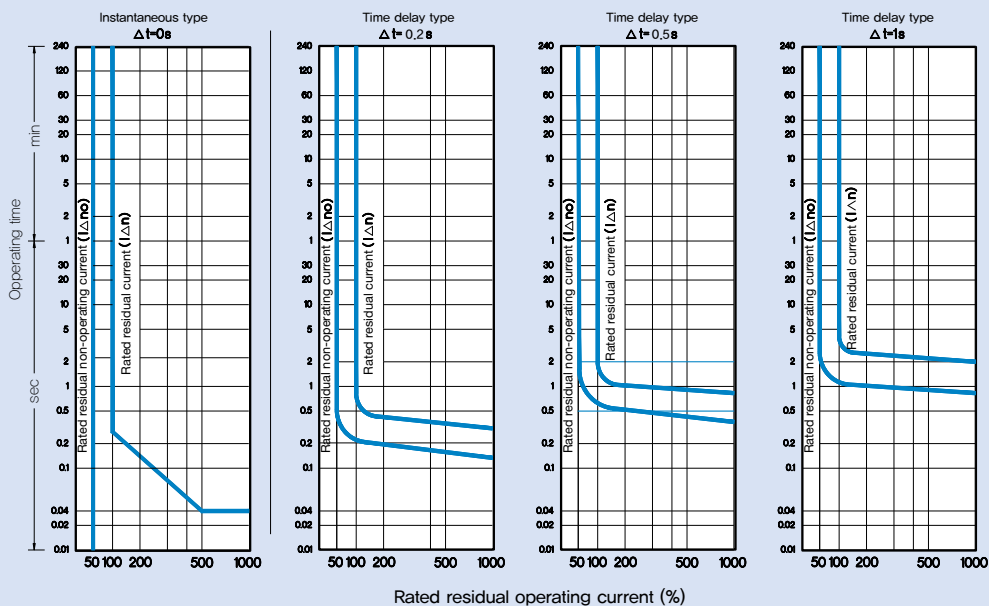

2A, 2s

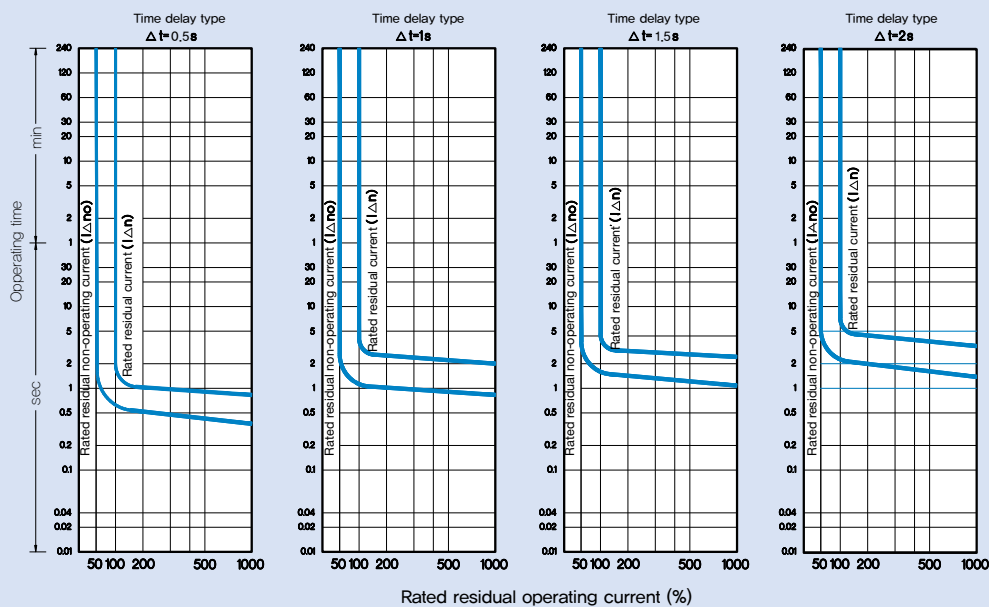

Characteristics curves

Motor protection type

Breaker types

MCCB

ABN50cM/60cM/100cM/100dM

ABS30cM/50cM/60cM

Rated current: 16~32A

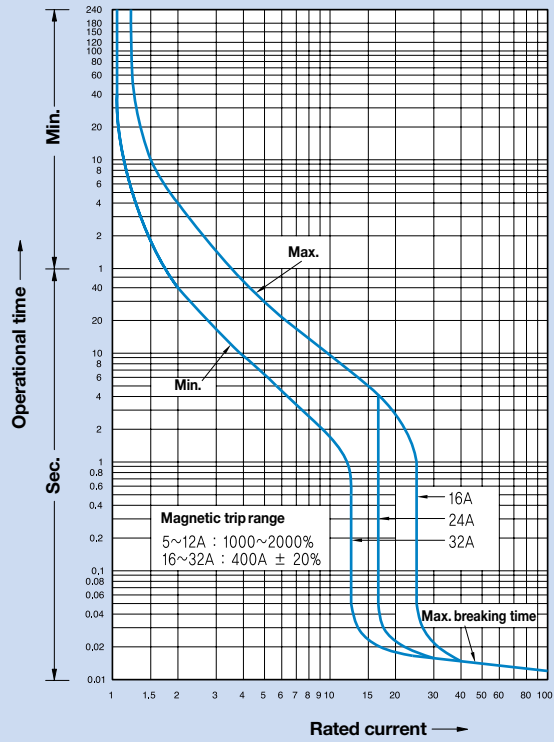

Compensation curves

Rated current: 16~32A

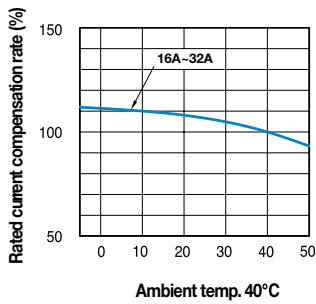

Rated current: 45~90A

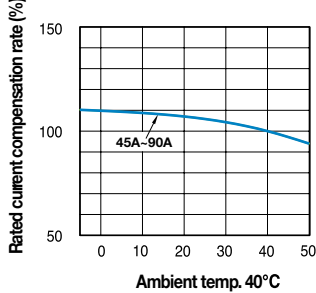

Rated current: 45~90A

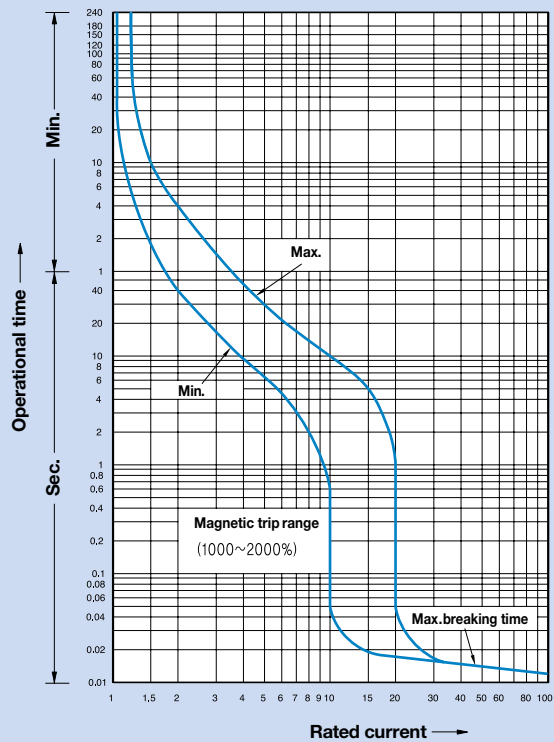

Breaker types

MCCB
ABS125cM
ABH50cM/125cM

Compensation curves

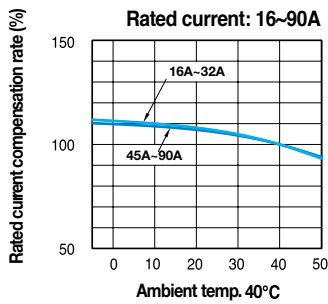

Rated current: 16~90A

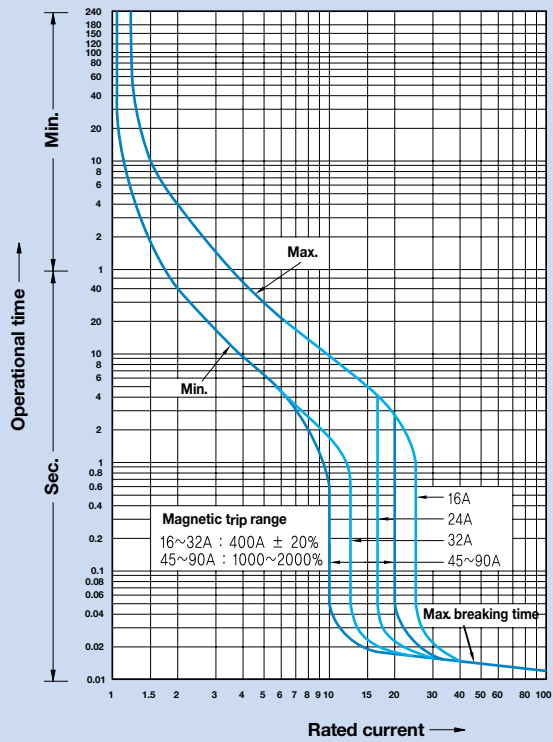

Breaker types

MCCB
ABN250cM, ABS250cM
ABH250cM

Compensation curves

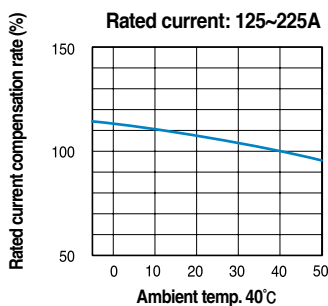

Rated current: 125~225A

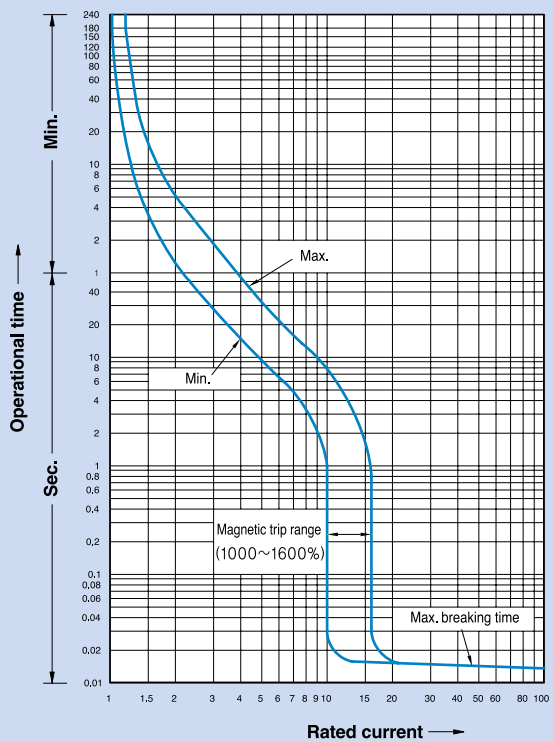

Dimensions

MCCB

ABE30b

(Unit: mm)

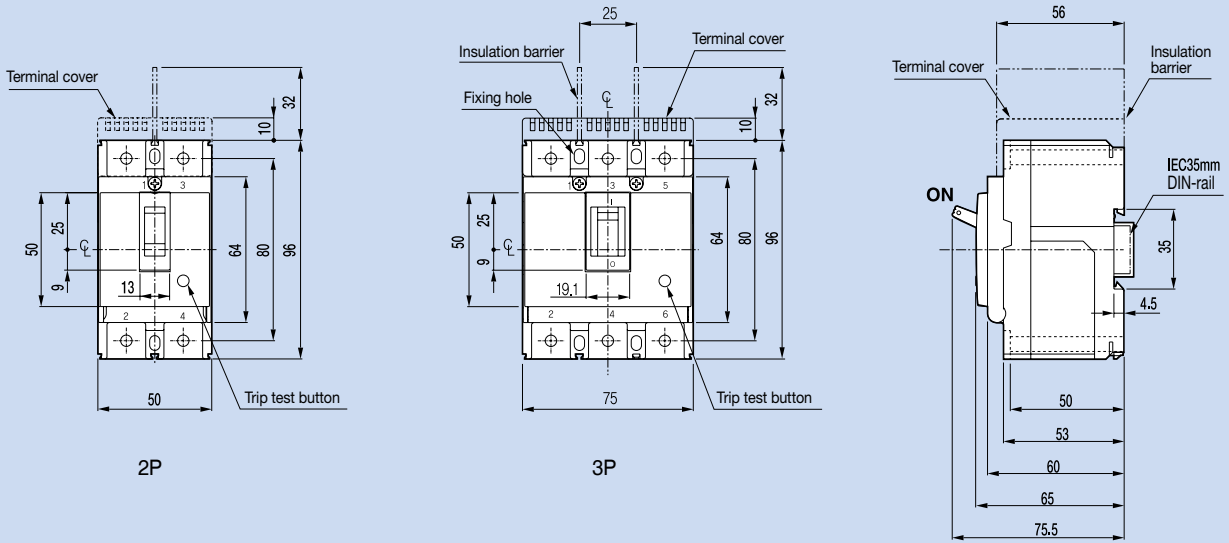

Terminal details

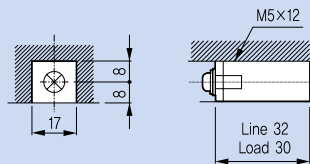

Panel drilling

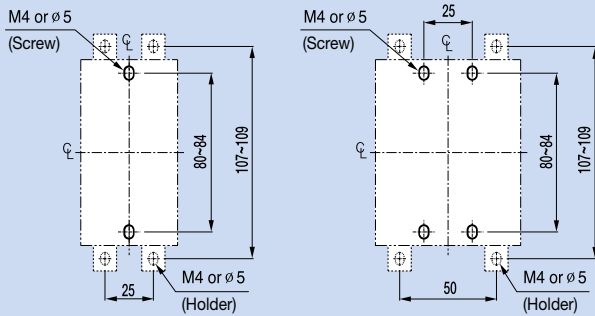

Front panel cutting

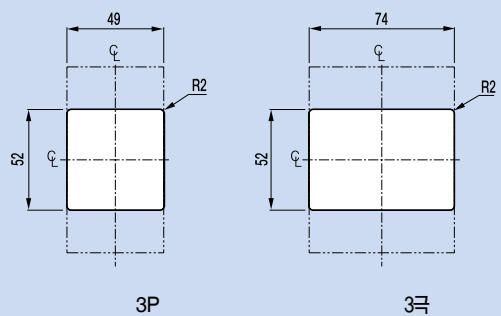

MCCB

ABN50c	ABS30c
ABN60c	ABS50c
ABN100c/100e	ABS60c

(Unit: mm)

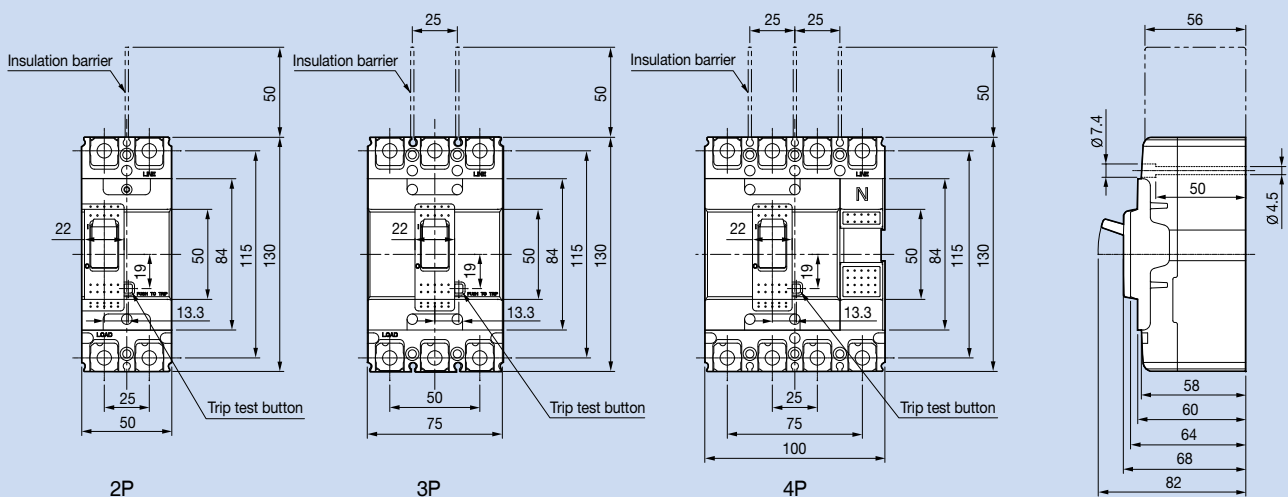

Terminal details

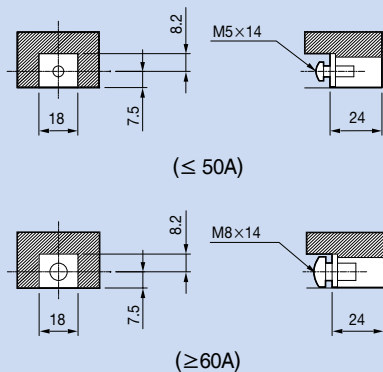

Connecting

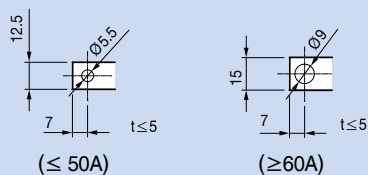

Panel drilling

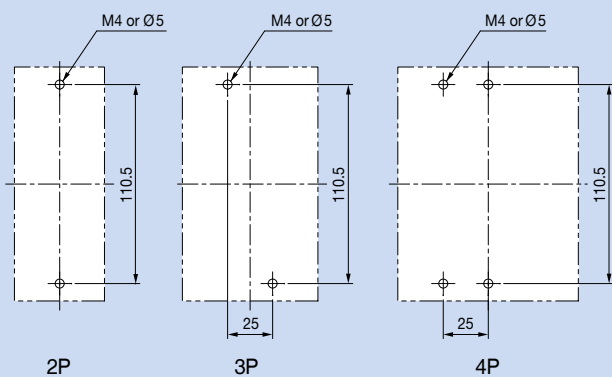

Front panel cutting

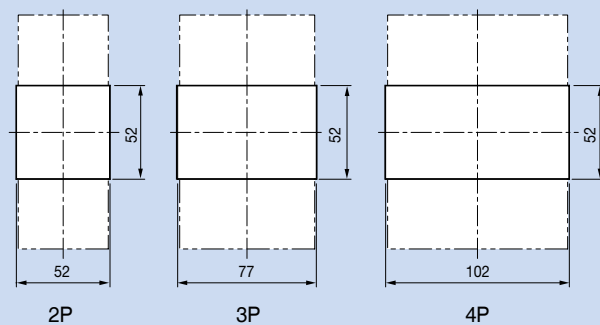

Dimensions

MCCB

ABS125c

ABH50c

ABH125c

ABL125c

(Unit: mm)

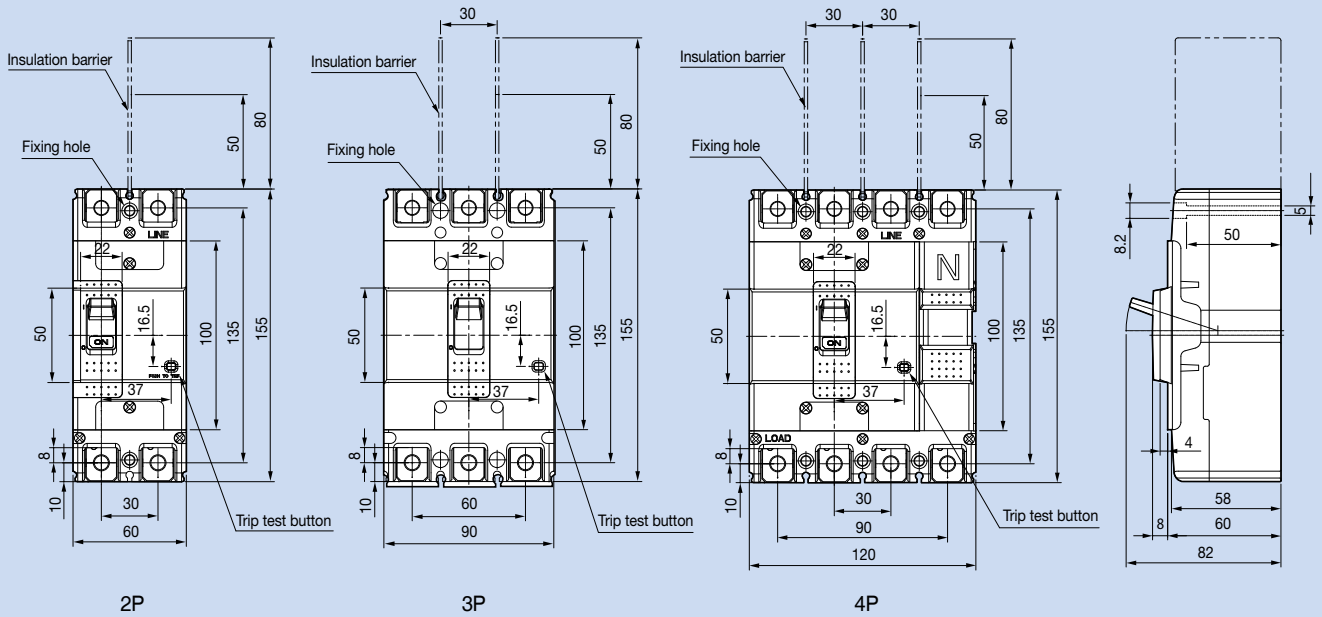

Terminal details

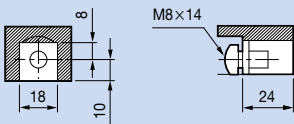

Connecting

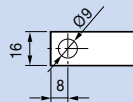

Panel drilling

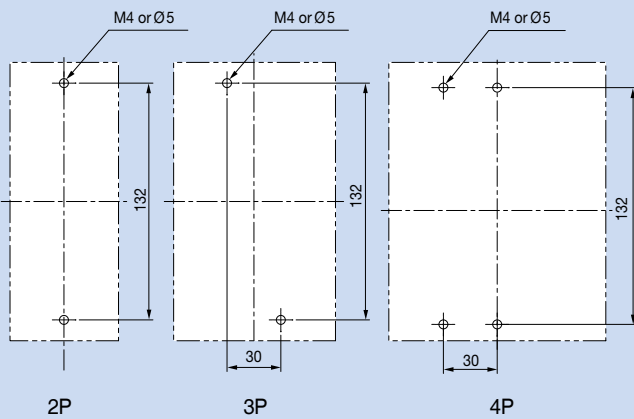

Front panel cutting

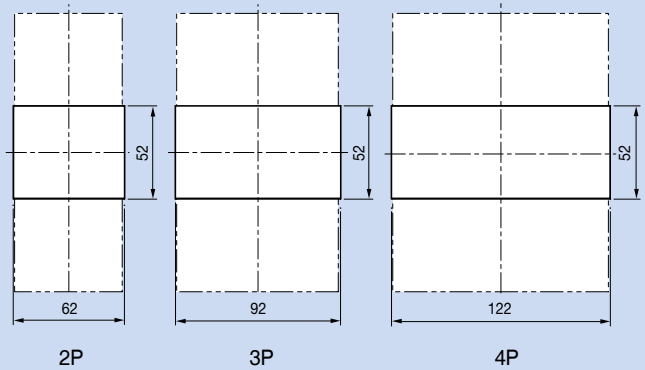

MCCB

- ABN250c
- ABS250c
- ABH250c
- ABL250c

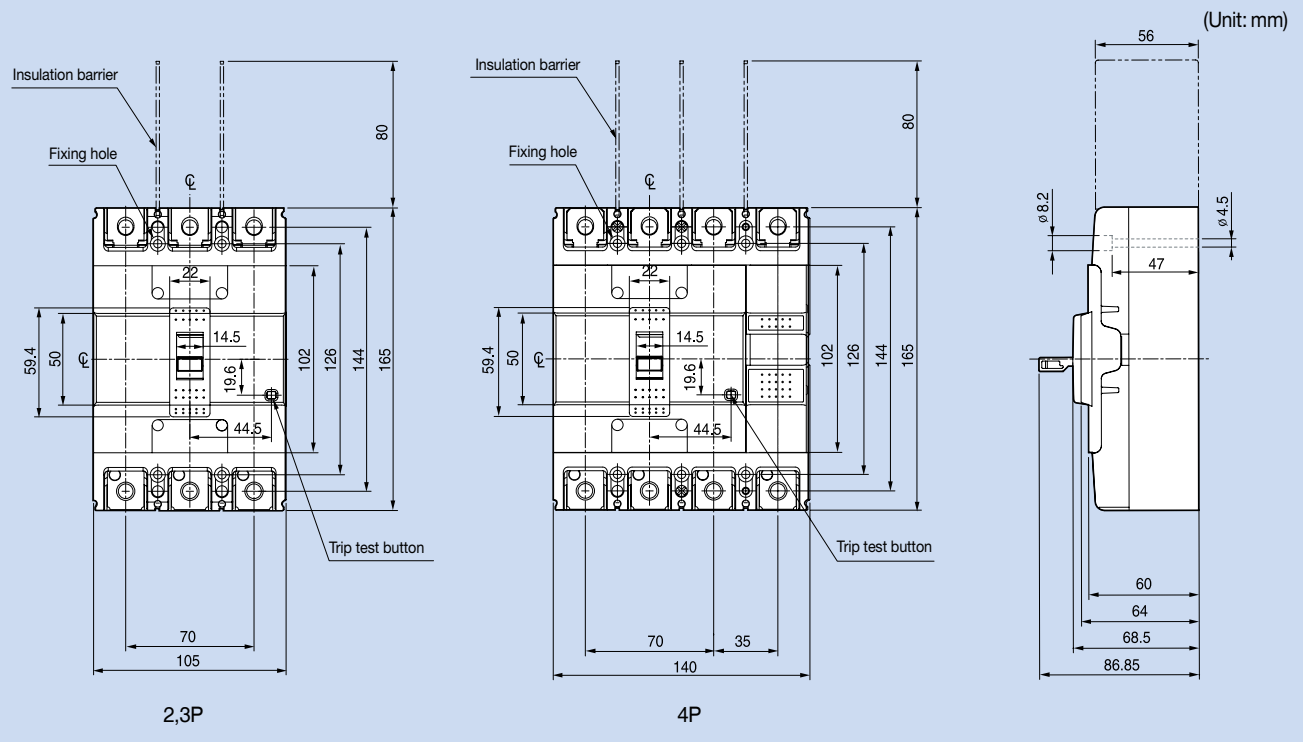

Terminal details

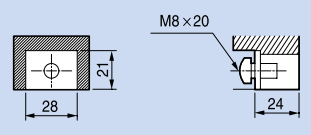

Connecting

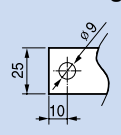

Panel drilling

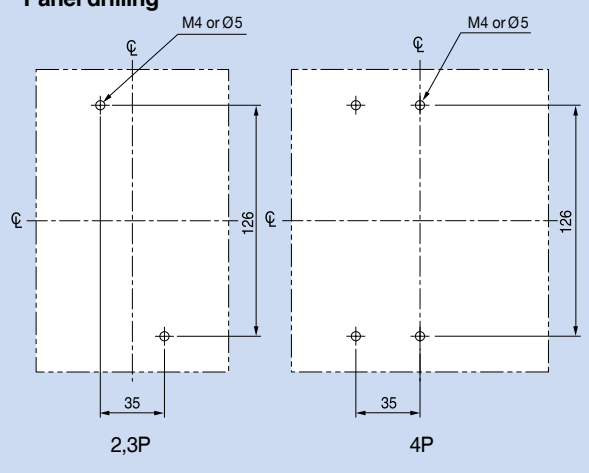

Front panel cutting

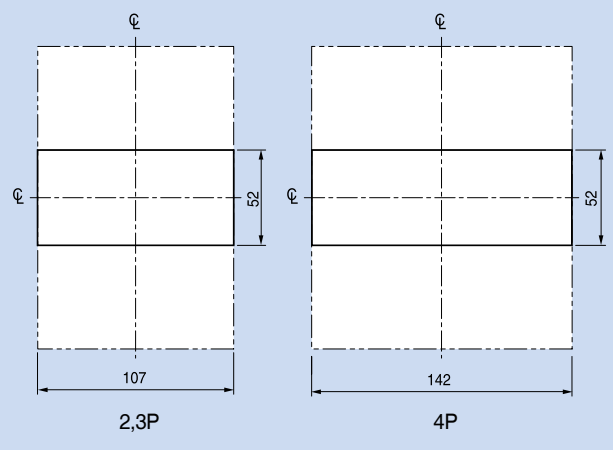

Dimensions

MCCB

- ABN400c
- ABS400c
- ABH400c
- ABL400c

(Unit: mm)

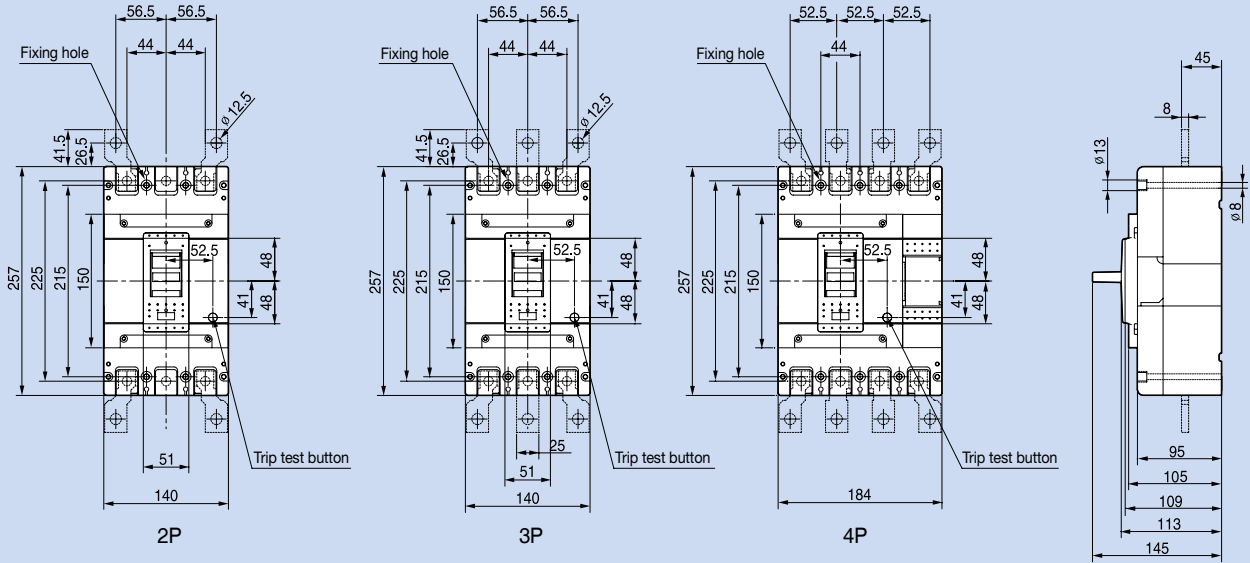

Terminal details

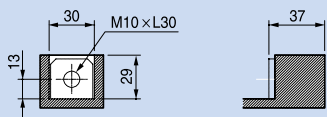

Connecting

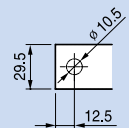

Panel drilling

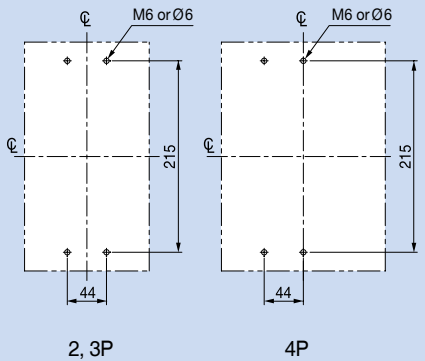

Front panel cutting

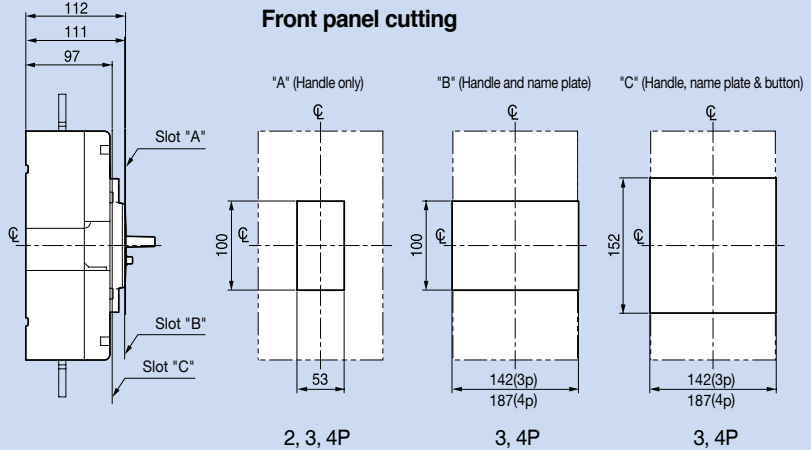

MCCB

ABN800c

ABS800c

ABL800c

(Unit: mm)

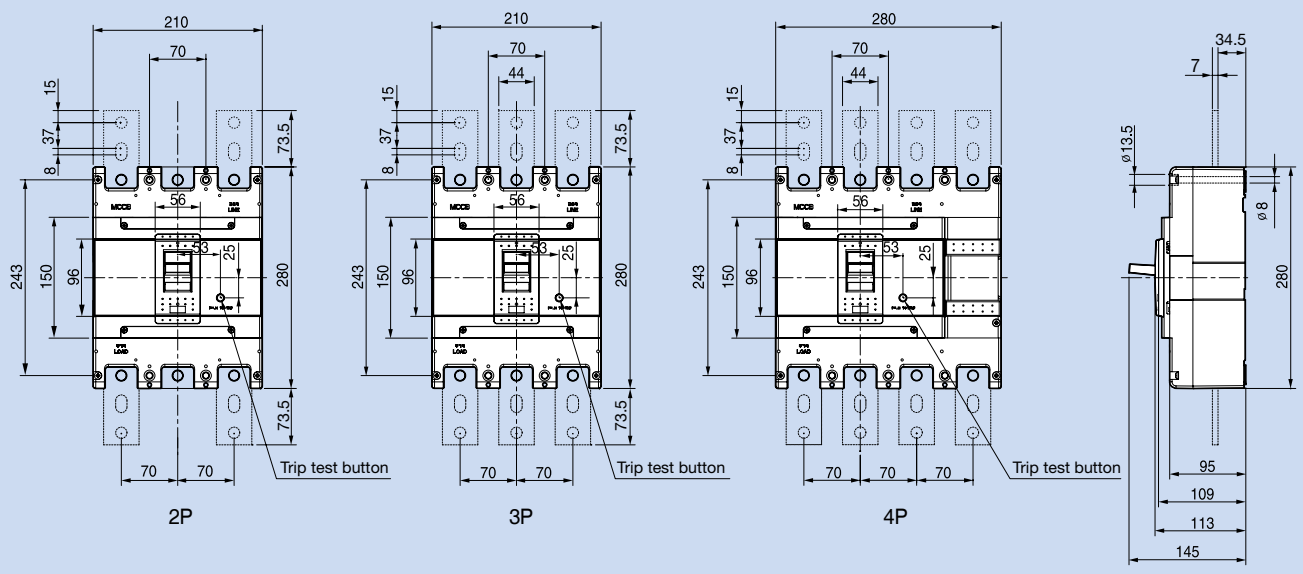

630AF : 7
800AF : 10

Terminal details

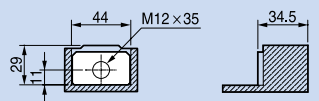

Connecting

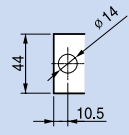

Panel drilling

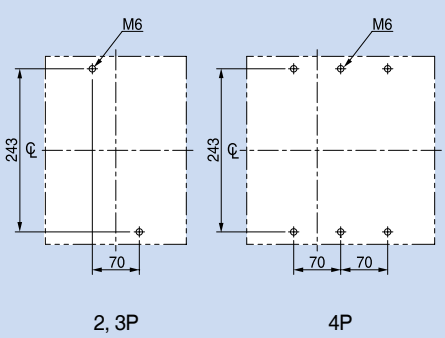

Front panel cutting

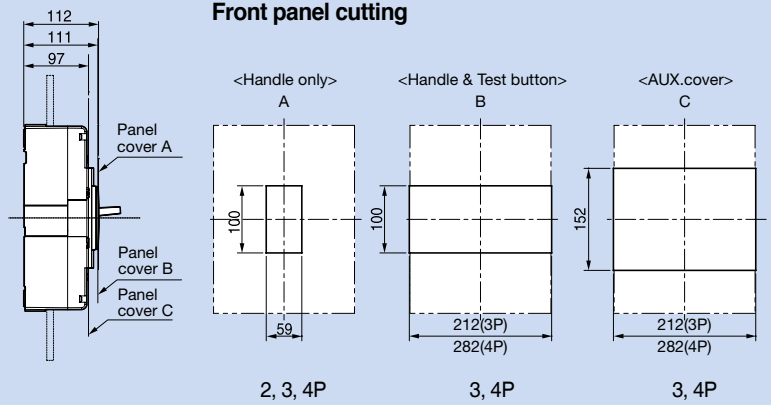

Dimensions

MCCB

ABS1000b	ABL1000b
ABS1200b	ABL1200b

(Unit: mm)

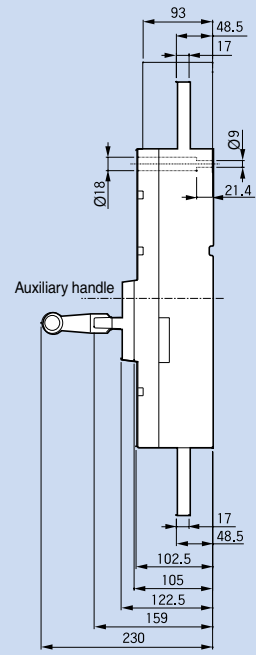
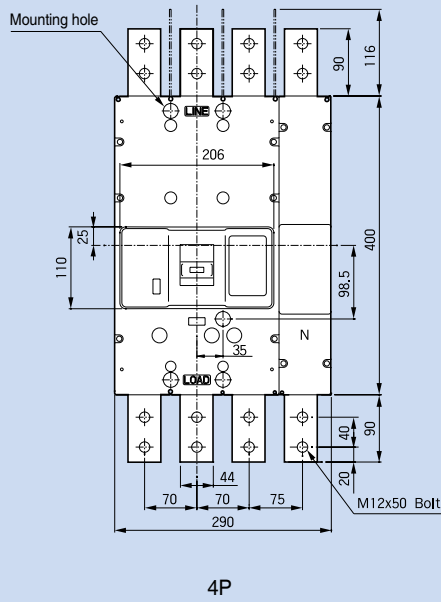
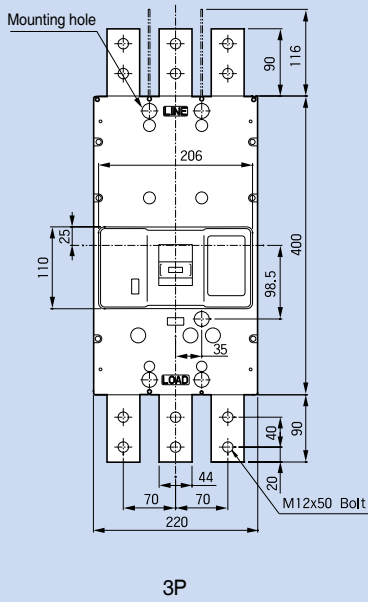

Panel drilling

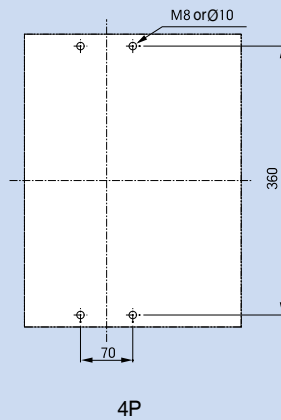
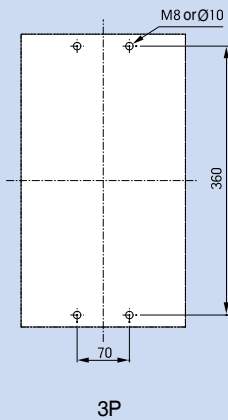

Front panel cutting

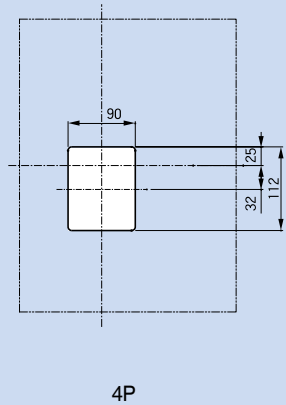
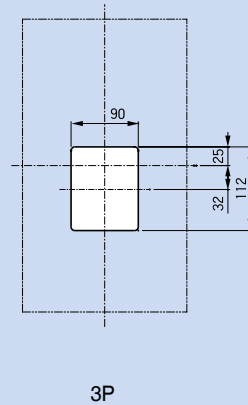

MCCB

ABS1203bE

(Unit: mm)

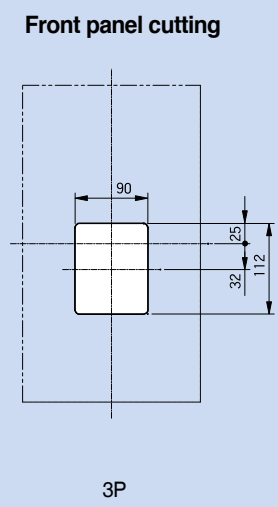
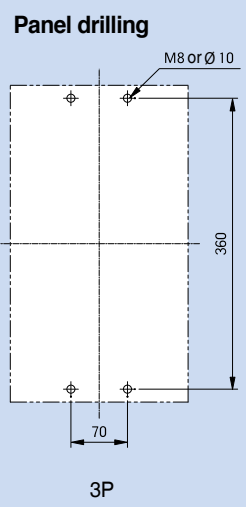
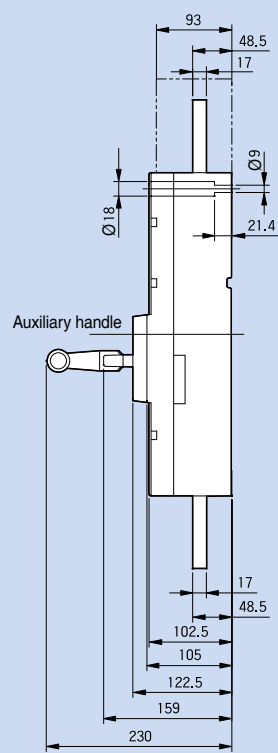
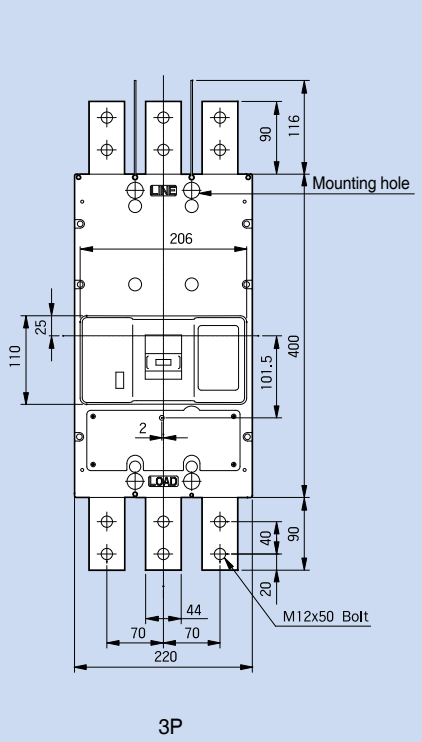

Dimensions

ELCB

EBN50c	EBS30c
EBN60c	EBS50c
EBN100c	EBS60c

(Unit: mm)

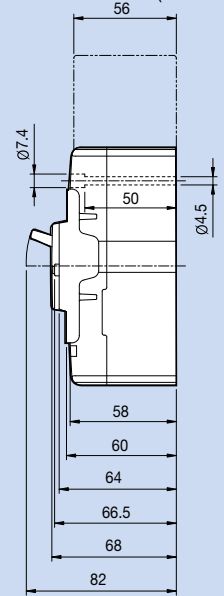
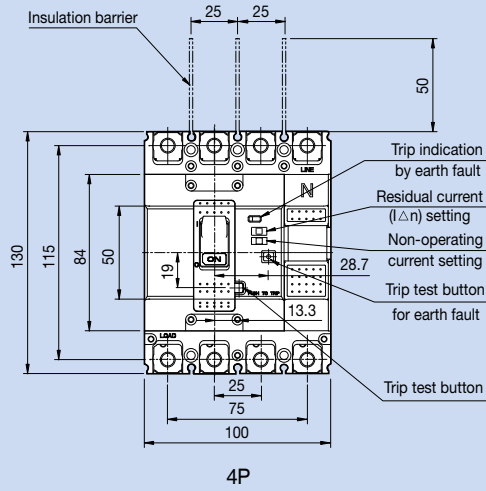
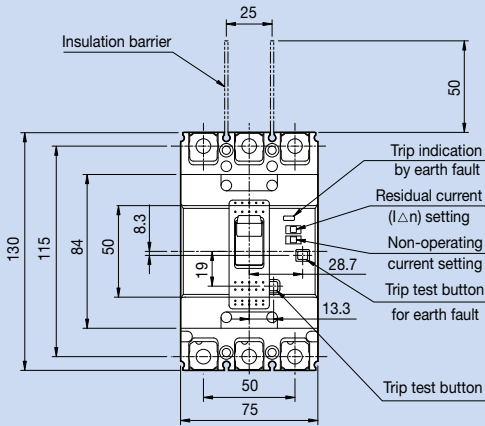

Terminal details

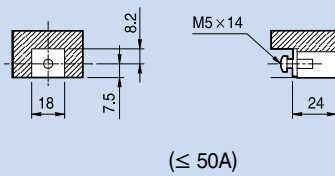

(≤ 50A)

Connecting

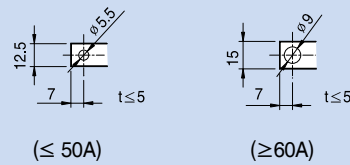

(≤ 50A)

(≥ 60A)

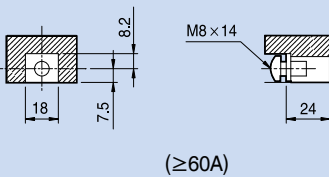

(≥ 60A)

Panel drilling

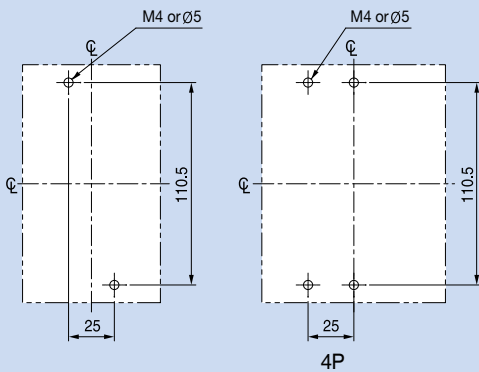

Front panel cutting

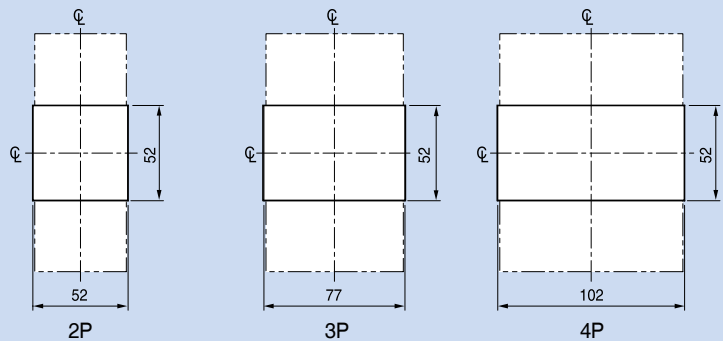

ELCB

EBS125c

EBH50c

EBH125c

(Unit: mm)

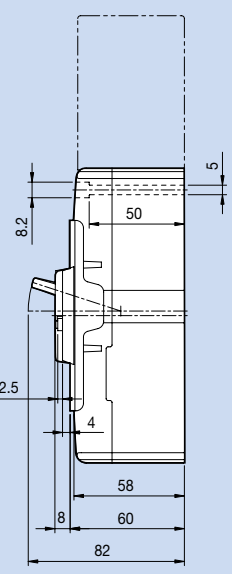
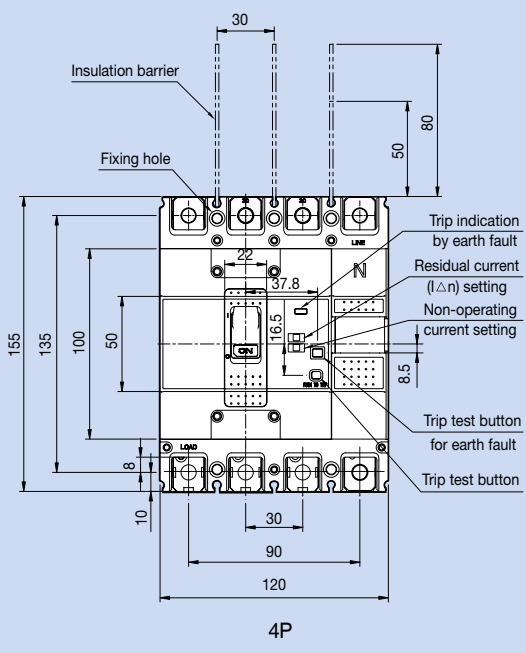
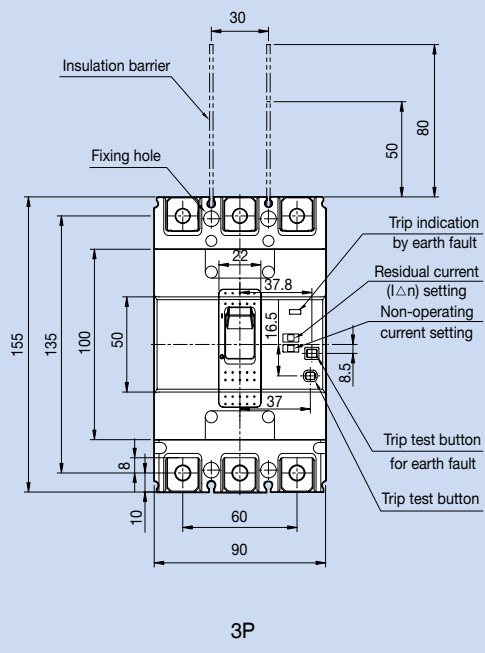

Terminal details

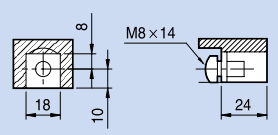

Connecting

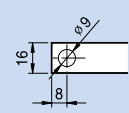

Panel drilling

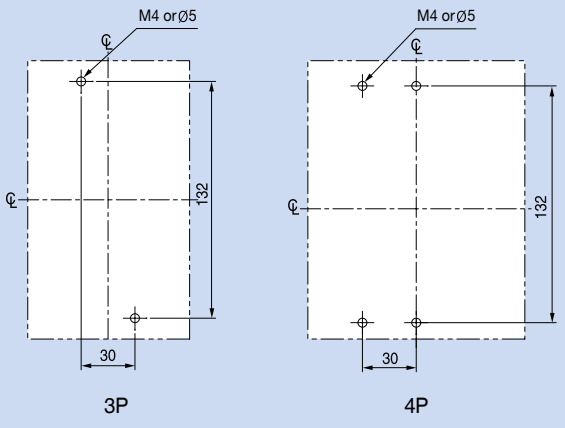

Front panel cutting

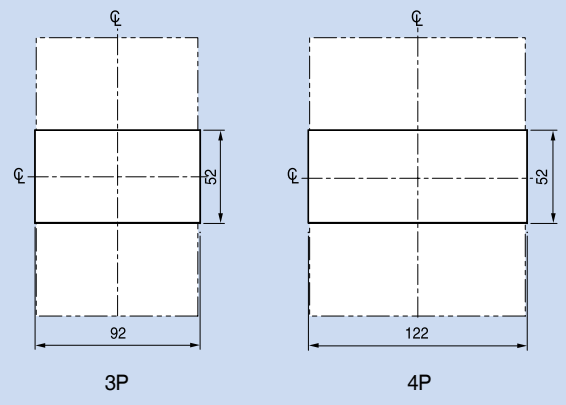

Dimensions

ELCB

EBN250c

EBS250c

EBH250c

(Unit: mm)

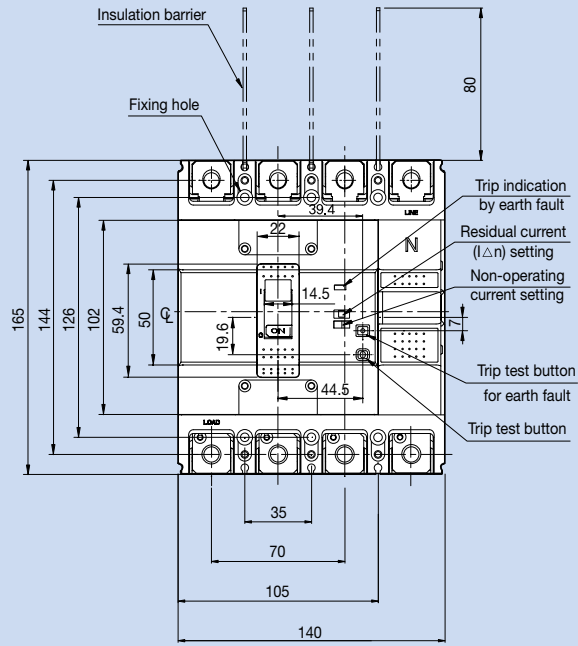
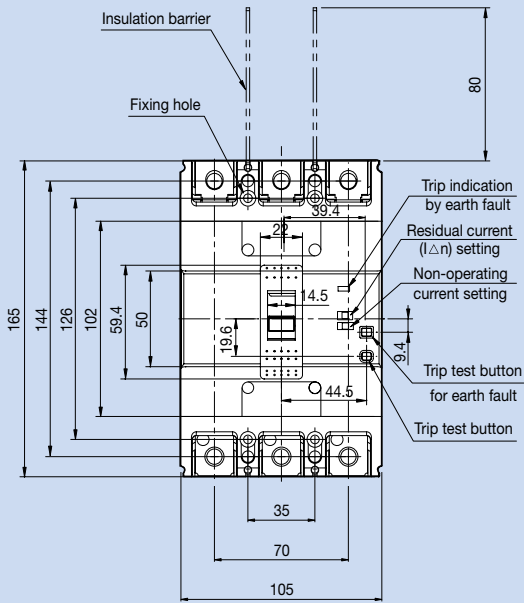

4P

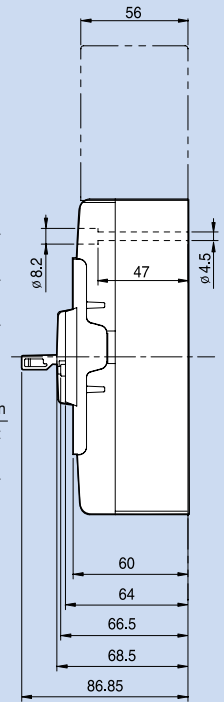

Terminal details

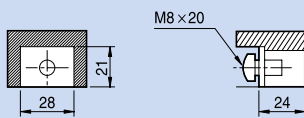

Connecting

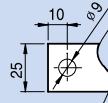

Panel drilling

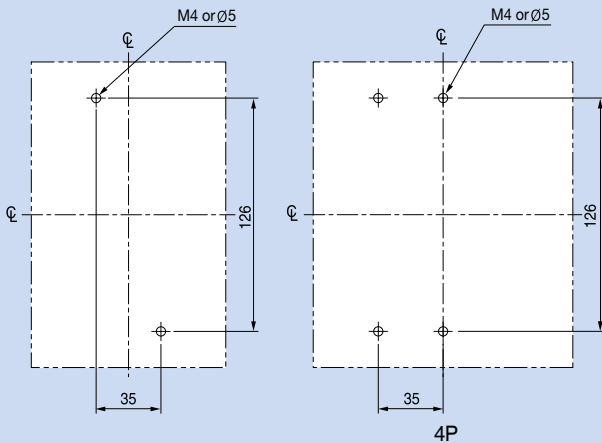

Front panel cutting

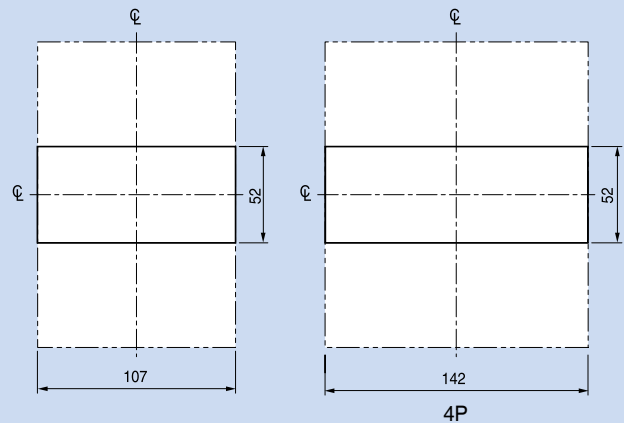

ELCB

- EBN400c
- EBS400c
- EBH400c
- EBL400c

(Unit: mm)

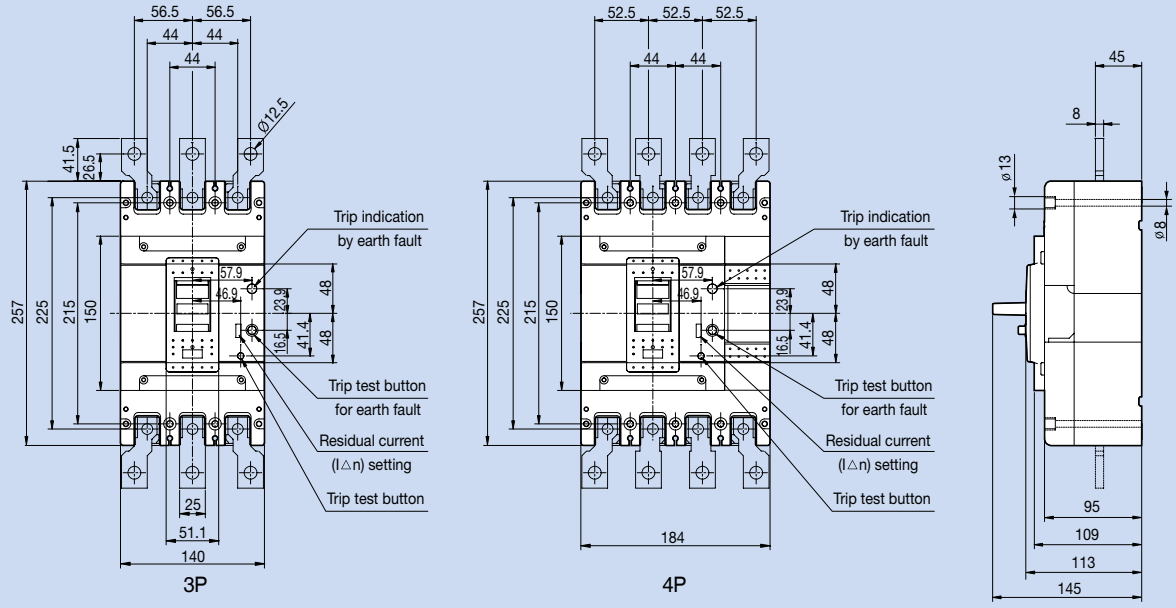

Terminal details

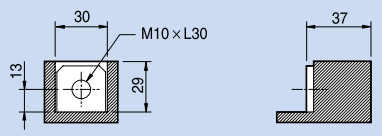

Connecting

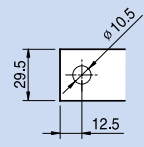

Panel drilling

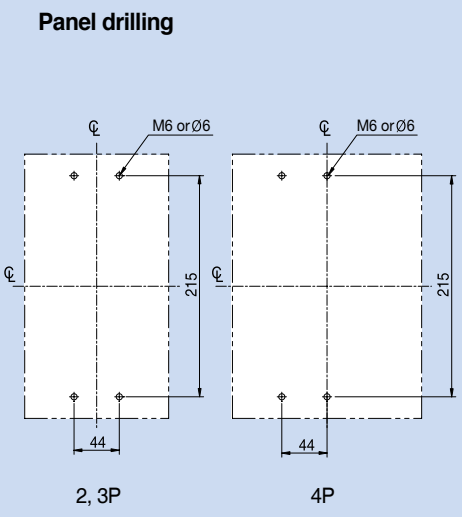

Front panel cutting

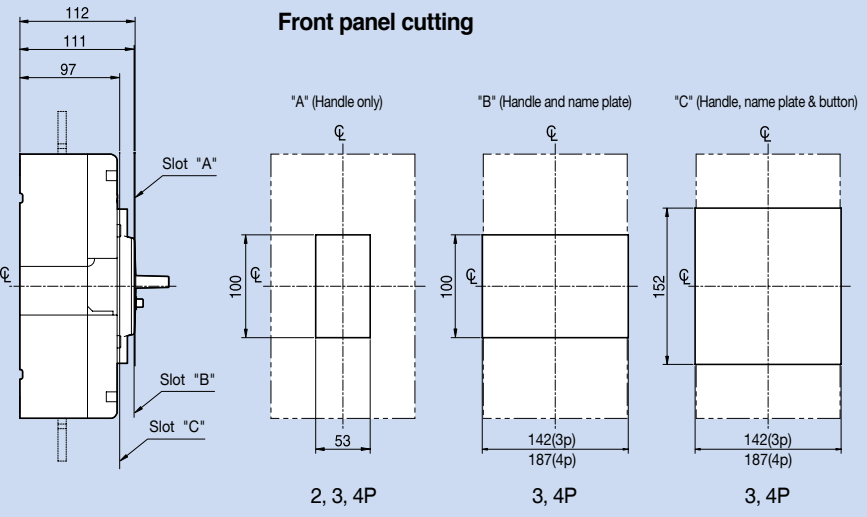

Dimensions

ELCB

EBN800c

EBS800c

EBL800c

(Unit: mm)

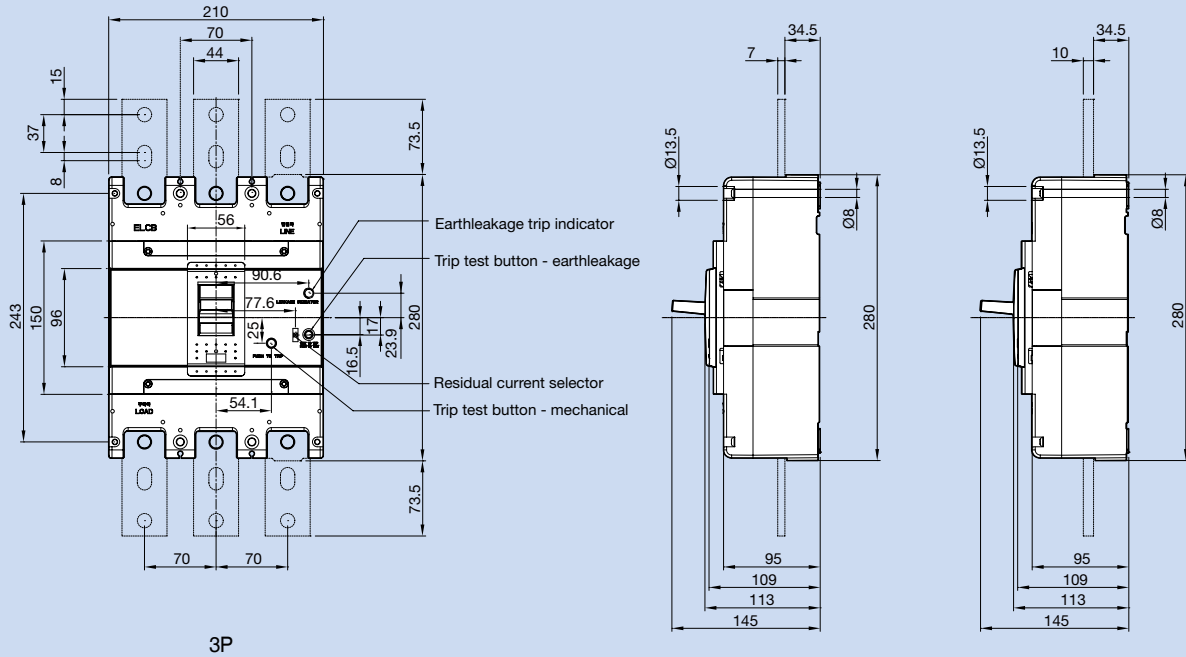

Terminal details

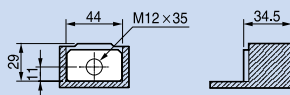

Connecting

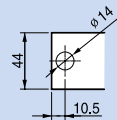

630AF : 7
800AF : 10

Panel drilling

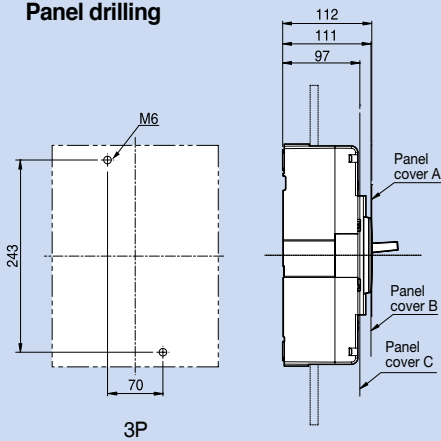

Front panel cutting

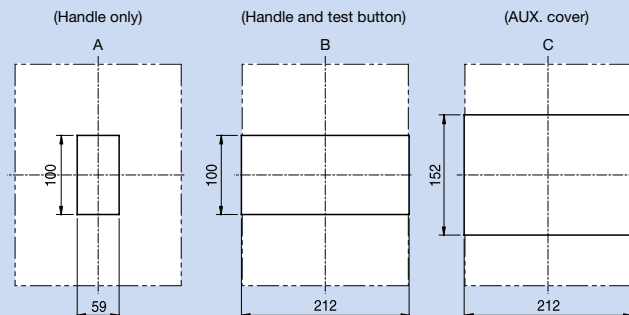

ELCB

EBS1000b
EBS1200b

(Unit: mm)

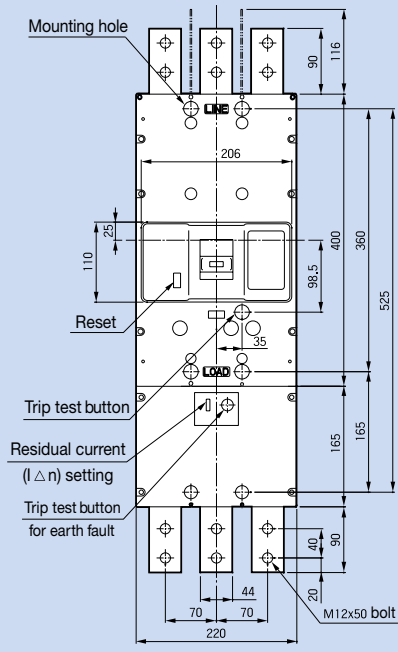

3P

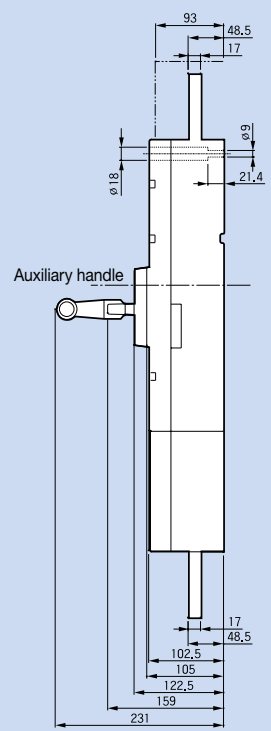

Panel drilling

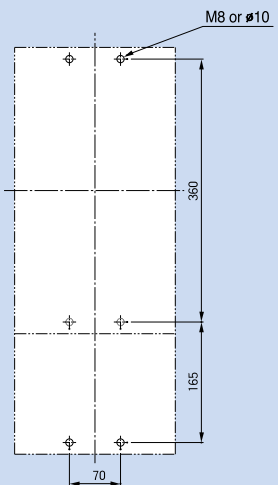

3P

Front panel cutting

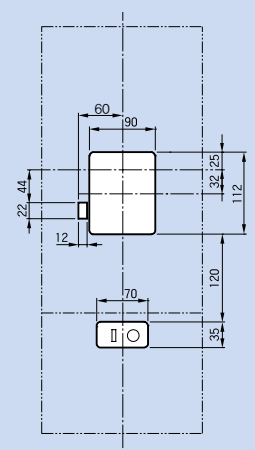

3P

Rear connection terminals

Bar type

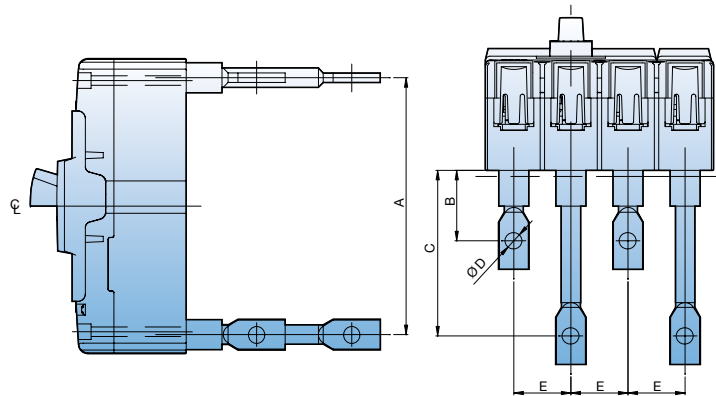

MCCB	A	B	C	D	E
ABN100c	115	37	87	Ø8.5	25
ABH125c	135	37	87	Ø8.5	30
ABH250c	144	57.5	93.5	Ø8.5	35

Round type

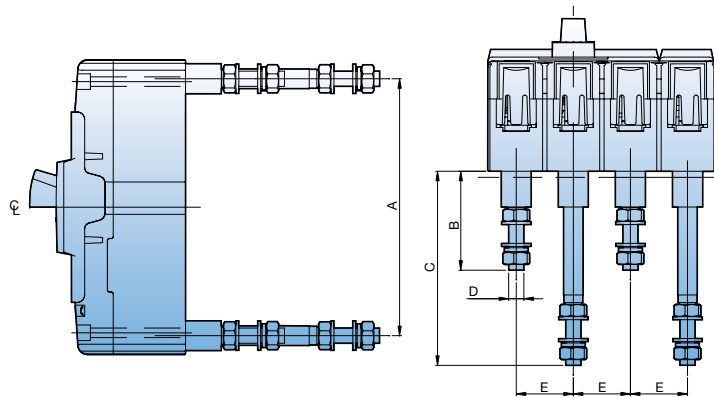

MCCB	A	B	C	D	E
ABN100c 50AF	115	42	92	M6	25
ABN100c 100AF	115	52	102	M8	25
ABH125c	135	52	102	M8	30
ABH250c	144	70	106	M8	35

Rotary handles

Direct mounting type (D-handle, 30~250AF)

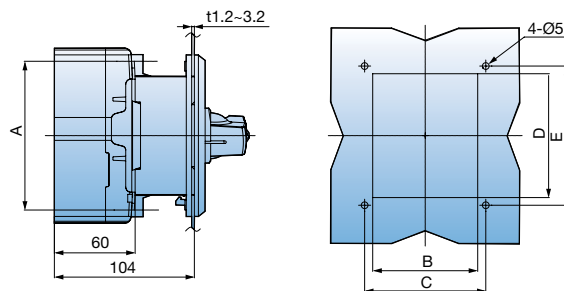

Type	A (mm)	B (mm)	C (mm)	D (mm)	E (mm)	Remarks
DH100	110.5	78	90	92	103.4	100AF
DH125	132	94	105	108	120	125AF
DH250	126	108	121	110	122	250AF

Direct mounting type (N-handle, 30~250AF)

N-30c, 40c, 50c

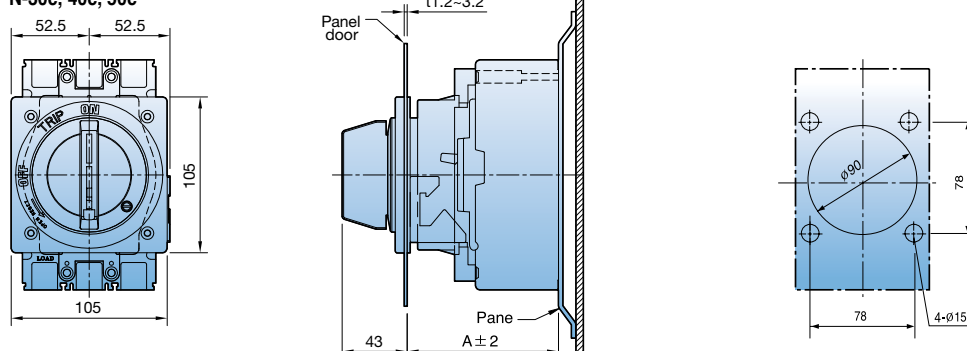

N-handle	N-30c	N-40c	N-50c
Note	100AF	125AF	250AF
A (mm)	103	103	103

Direct mounting type (N-handle, 400~800AF)

N-70, N-80

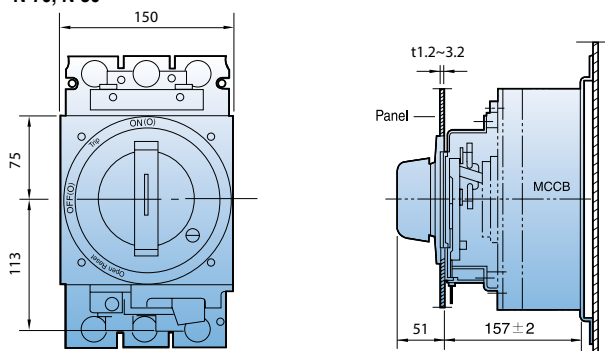

Rotary handles

Extended mounting type (E-handle) (30~250AF)

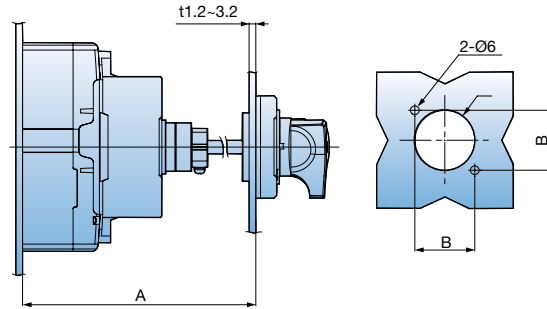

Type	A (mm)	B (mm)	C (mm)	Remarks
EH100	min 150, max 573.5 (Shaft 469mm)	47	Ø53	100AF
EH125	min 150, max 573.5 (Shaft 469mm)	47	Ø53	125AF
EH250	min 150, max 571.5 (Shaft 469mm)	47	Ø53	250AF

Extended mounting type (N-handle, 400~800AF)

E-70U (400AF)

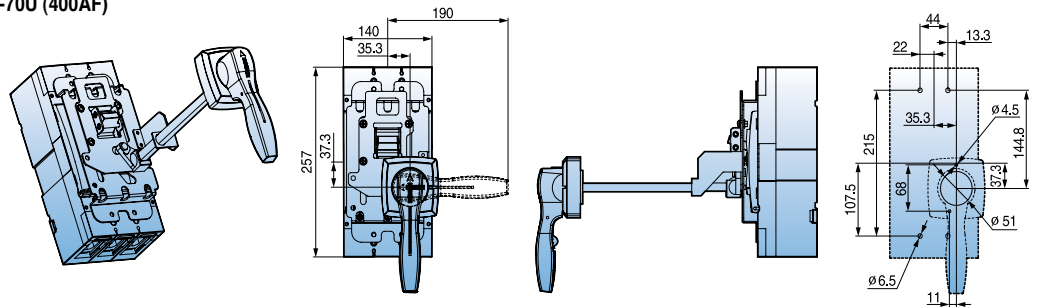

E-80U (800AF)

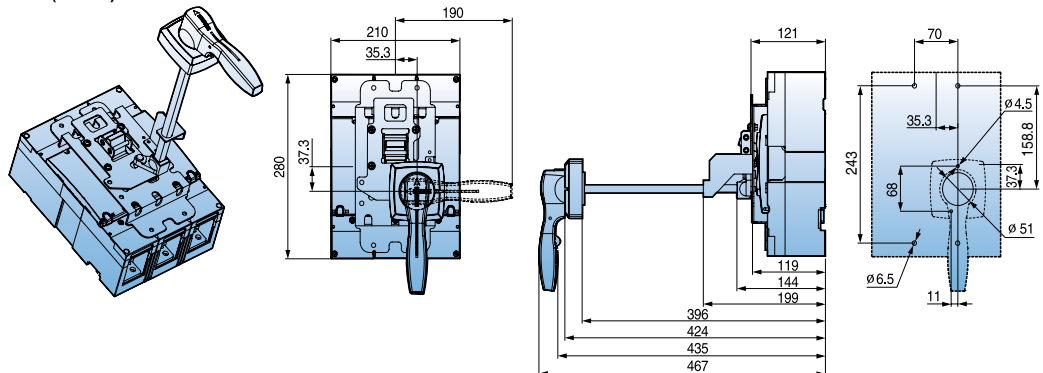



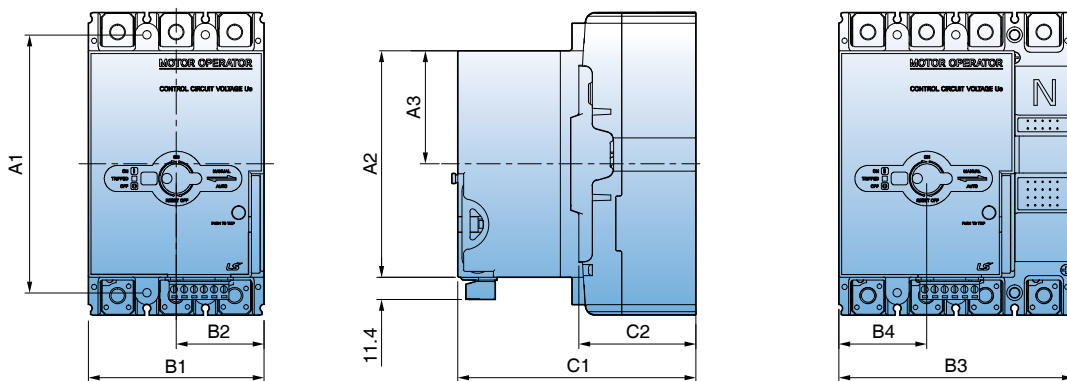











Remote operation



	A1	A2	A3	B1	B2	B3	B4	C1	C2
MOP-M1	110.5	102	51	75	37.5	100	37.5	128	60
MOP-M2	132	116	58	90	45	120	45	122	60
MOP-M3	126	116	55	105	52.5	140	52.5	125	60
MOP-M4	215	176	88	140	70	184	70	198	109
MOP-M5	243	176	88	210	105	280	105	198	109
MOP-M6	322.5	176	65.5	220	110	289	110	210	105

Standard accessories

The following accessories for mounting, connection and insulation are standard items and are packed with Metasol series circuit breakers.

Item	100AF	125AF	250AF	400AF	800AF
Fixing screw					
	2P: 2EA (M4 × 60) 3P: 2EA (M4 × 60) 4P: 4EA (M4 × 60)	2P: 2EA (M4 × 60) 3P: 2EA (M4 × 60) 4P: 4EA (M4 × 60)	2P: 2EA (M4 × 55) 3P: 2EA (M4 × 55) 4P: 4EA (M4 × 55)	2P: 4EA (M6 × 100) 3P: 4EA (M6 × 100) 4P: 4EA (M6 × 100)	2P: 4EA (M6 × 100) 3P: 4EA (M6 × 100) 4P: 4EA (M6 × 100)
Terminal bolt					
	3~50A 2P: 4EA (M5 × 14) 3P: 6EA (M5 × 14) 4P: 8EA (M5 × 14) 60~100A 2P: 4EA (M8 × 14) 3P: 6EA (M8 × 14) 4P: 8EA (M8 × 14)	2P: 4EA (M8 × 14) 3P: 6EA (M8 × 14) 4P: 8EA (M8 × 14)	2P: 4EA (M8 × 20) 3P: 6EA (M8 × 20) 4P: 8EA (M8 × 20)	2P: 4EA (M10 × 30) 3P: 6EA (M10 × 30) 4P: 8EA (M10 × 30)	2P: 4EA (M12 × 35) 3P: 6EA (M12 × 35) 4P: 8EA (M12 × 35)
Insulation barrier					
	2P: 1EA 3P: 2EA 4P: 3EA	2P: 1EA 3P: 2EA 4P: 3EA	2P: 1EA 3P: 2EA 4P: 3EA	2P: 1EA 3P: 2EA 4P: 3EA	2P: 1EA 3P: 2EA 4P: 3EA

Fixing screws for rotary handles

Handle type	N-30c	N-40c	N-50c	N-70	N-80
Applied MCCB	ABN 50c/60c/100c ABS 30c/50c/60c ABN100e	ABS 125c ABH 50c ABH 125c ABL 125c	ABN 250c ABS 250c ABH 250c ABL 250c	ABN 400c ABS 400c ABH 400c ABL 400c	ABN 800c ABS 800c ABL 800c
Applied ELCB	EBN 50c/60c/100c EBS 30c/50c/60c	EBS 125c EBH 50c EBH 125c	EBN 250c EBS 250c EBH 250c	EBN 400c EBS 400c EBH 400c EBL 400c	EBN 800c EBS 800c EBL 800c
Fixing screw (short)	-	-	-	M6 × 16	M6 × 16
Fixing screw (long)	M4 × 85	M4 × 85	M4 × 85	M6 × 110	M6 × 110

Handle type	DH/EH100	DH/EH125	DH/EH250
Fixing screw	M4 × 70	M4 × 70	M4 × 70

Connection

MCCB	Terminal (mm)	Tightening torque (kgf · cm)	Conductor (mm)
100AF	[3~50A] <p>Terminal dimensions: 18mm width, 7.5mm height, 8.2mm depth. Screw: M5x 14. Mounting hole offset: 24mm.</p>	<p>M5: 23 ~ 28 M8: 55 ~ 75</p>	[3~50A] <p>Conductor dimensions: 7mm width, 11.5mm height. Hole diameter: Ø 5.5.</p>
	[60~100A] <p>Terminal dimensions: 18mm width, 7.5mm height, 8.2mm depth. Screw: M8x 14. Mounting hole offset: 24mm.</p>		[60~100A] <p>Conductor dimensions: 7mm width, 16mm height. Hole diameter: Ø 9.</p>
125AF	<p>Terminal dimensions: 18mm width, 10mm height, 8mm depth. Screw: M8x 14. Mounting hole offset: 24mm.</p>	<p>M8: 55 ~ 75</p>	<p>Conductor dimensions: 8mm width, 18mm height. Hole diameter: Ø 9.</p>
250AF	<p>Terminal dimensions: 28mm width, 21mm height, 24mm depth. Screw: M8x 20. Mounting hole offset: 24mm.</p>	<p>M8: 80 ~ 130</p>	<p>Conductor dimensions: 10mm width, 25mm height. Hole diameter: Ø 9.</p>

Connection

MCCB	Terminal (mm)	Tightening torque (kgf · cm)	Conductor (mm)
400AF		<p>M10: 240~300 (Terminal) M12: 400~500 (Busbar)</p>	
800AF		<p>M12: 400~500 (Terminal, Busbar)</p>	

Safety clearance

When installing a circuit breaker, safety clearances must be kept between the breaker and panels, bars and other protection devices installed nearby. These safety clearances are depend on the ultimate breaking capacity and are defined by tests carried out in accordance with standard IEC 60947-2.

When a short circuit interruption occur, high temperatures pressures are present in and above the arc chambers of the circuit-breaker. In order to allow the pressure to be distributed and to prevent fire and arcing or short-circuit currents, safety clearances are required.

A: Minimum distance to metallic top panels

Frame size	Description	A (mm)	
		460V	250V
100AF	ABN50c	40	25
	ABN60c	40	25
	ABN100c	50	30
	ABN100e	50	30
	ABS30c	30	25
	ABS50c	40	30
	ABS60c	40	30
125AF	ABS125c	50	40
	ABH50c	50	40
	ABH125c	100	80
	ABL125c	100	80
250AF	ABN250c	100	80
	ABS250c	100	80
	ABH250c	100	80
	ABL250c	100	80
400AF	ABN400c	100	80
	ABS400c	100	80
	ABH400c	100	80
	ABL400c	100	80
800AF	ABN800c	100	80
	ABS800c	100	80
	ABL800c	100	80

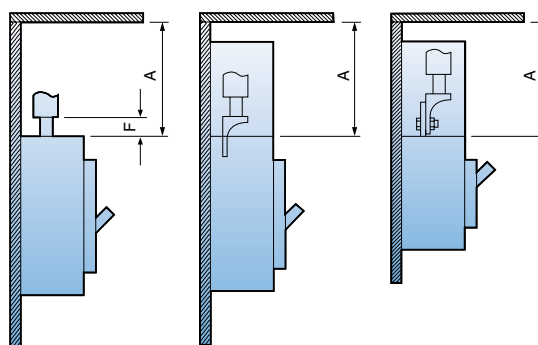

Technical information

B: Minimum distance between the lower and the upper breakers

- C1: Minimum distance between the lower breaker and the bare terminal of the upper breaker
- C: C1+ the dimension of bare part of conductor

Frame size	Description	C1 (mm)		C (mm)
		460V	250V	
100AF	ABN50c	40	25	
	ABN60c	40	25	
	ABN100c	50	30	
	ABN100e	50	30	
	ABS30c	30	25	
	ABS50c	40	30	
125AF	ABS60c	40	30	
	ABS125c	50	40	
	ABH50c	50	40	
	ABH125c	100	80	
250AF	ABL125c	100	80	
	ABN250c	100	80	
	ABS250c	100	80	
	ABH250c	100	80	
400AF	ABL250c	100	80	
	ABN400c	100	80	
	ABS400c	100	80	
	ABH400c	100	80	
800AF	ABL400c	100	80	
	ABN800c	100	80	
	ABS800c	100	80	
	ABL800c	100	80	

The dimension of bare conduct + C1

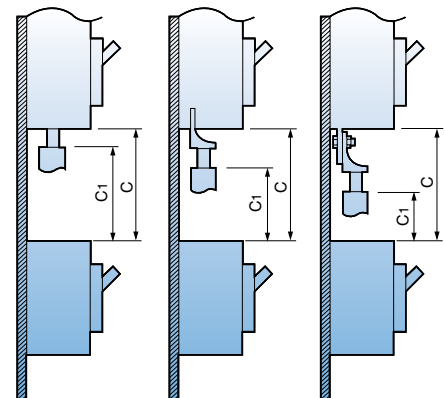

Direct connection of cable

Connection by using a crimp-type terminal lug

Connection by using a crimp-type terminal lug to the extended terminal

Safety clearance

Insulated length of main terminal of circuit breaker

- D1: Connection by solderless terminal with taping
- D2: Connection by busbar with taping
- D3: Connection by solderless terminal and using insulation barrier
- D4: Connection by busbar and using insulation barrier

Frame size	Description	D1 (mm)	D2 (mm)	D3 (mm)	D4 (mm)
100AF	ABN50c	The dimension of bare conduct + 20	40	The dimension of bare conduct + 20	40
	ABN60c		40		40
	ABN100c		50		50
	ABN100e		50		50
	ABS30c		30		30
	ABS50c		40		40
	ABS60c		40		40
125AF	ABS125c		50		50
	ABH50c		50		50
	ABH125c		50		50
	ABL125c		50		50
250AF	ABN250c		50		50
	ABS250c		50		50
	ABH250c		50		50
	ABL250c	50	50		
400AF	ABN400c	100	100		
	ABS400c	100	100		
	ABH400c	100	100		
	ABL400c	100	100		
800AF	ABN800c	150	150		
	ABS800c	150	150		
	ABL800c	150	150		

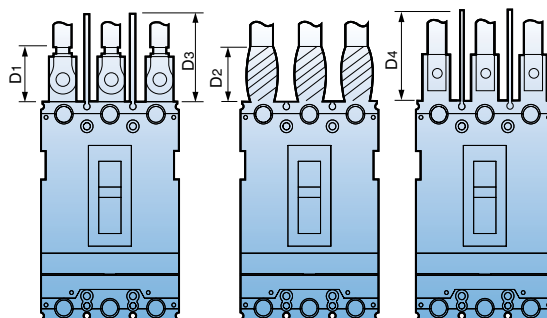

Minimum distance to metallic side panels

Frame size	Description	E (mm)	
		460V	250V
100AF	ABN50c	25	15
	ABN60c	25	15
	ABN100c	25	15
	ABN100e	25	15
	ABS30c	20	15
	ABS50c	25	15
	ABS60c	25	15
125AF	ABS125c	25	15
	ABH50c	25	15
	ABH125c	50	20
	ABL125c	50	20
250AF	ABN250c	50	15
	ABS250c	50	15
	ABH250c	50	15
	ABL250c	50	15
400AF	ABN400c	80	40
	ABS400c	80	40
	ABH400c	80	40
	ABL400c	80	40
800AF	ABN800c	80	40
	ABS800c	80	40
	ABL800c	80	40

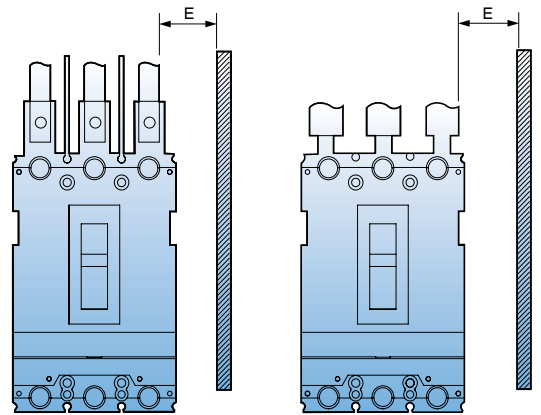

Safety clearance

Distance of bare cables or busbars

Frame size	Description	F (mm)
100AF	ABN50c	10
	ABN60c	10
	ABN100c	-
	ABN100e	-
	ABS30c	5
	ABS50c	10
	ABS60c	10
125AF	ABS125c	-
	ABH50c	10
	ABH125c	20
	ABL125c	-
250AF	ABN250c	-
	ABS250c	-
	ABH250c	-
	ABL250c	-
400AF	ABN400c	10
	ABS400c	10
	ABH400c	10
	ABL400c	10
800AF	ABN800c	10
	ABS800c	10
	ABL800c	10

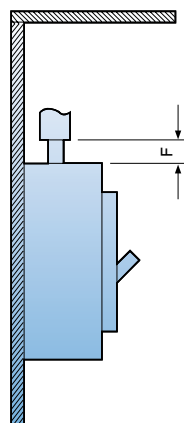

Minimal distance between two adjacent breakers (With terminal covers)

Frame size	Description	G (mm)
100AF	ABN50c	0
	ABN60c	0
	ABN100c	0
	ABN100e	0
	ABS30c	0
	ABS50c	0
	ABS60c	0
125AF	ABS125c	0
	ABH50c	0
	ABH125c	0
	ABL125c	0
250AF	ABN250c	0
	ABS250c	0
	ABH250c	0
	ABL250c	0
400AF	ABN400c	0
	ABS400c	0
	ABH400c	0
	ABL400c	0
800AF	ABN800c	0
	ABS800c	0
	ABL800c	0

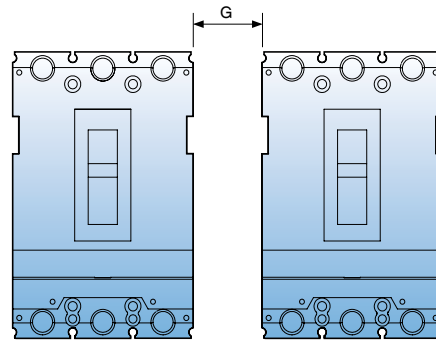

Insulation resistance (IR) testing & withstand voltage testing (For ELCB)

Insulation resistance (IR) testing

Insulation resistance marked as Δ in table1 is not destroyed when 500V is applied using insulation tester but when 1000V is applied. Conduct the testing when the indicator needle of insulation tester wavers greatly. Make sure ELCB is Off before testing.

Withstand voltage testing

When conducting IR testing and withstand voltage testing, Do Not apply voltage for those marked as X in Table1.

Table1. insulation resistance (IR) testing & withstand voltage testing

Application circuit breaker	Application circuit breaker	Insulation resistance (IR) testing		Withstand voltage testing	
		On	Off	On	Off
handle status		On	Off	On	Off
Charge-earth		○	○	○	○
R-S, S-T, R-T	Line	Δ	Δ	×	○
	Load	Δ	Δ	×	×
Line-load		—	○	—	○

Standards & approval

Metasol series circuit breakers and auxiliaries comply with the following international standard:

- IEC 60947-1
Low-voltage switchgear and controlgear - Part 1: General rules
- IEC 60947-2
Low-voltage switchgear and controlgear - Part 2: Circuit-breakers

The following certificates are available on a request.

- CE Declaration of conformity
- Certificate of conformance test (CB) - IEC 60947
- Full type test report issued by KEMA

CE conformity marking

The CE conformity marking shall indicate conformity to all the obligations imposed on the manufacturer, as regards his products, by virtue of the European community directives providing for the affixing of the CE marking.

When the CE marking is affixed on a product, it represents a declaration of the manufacturer or of his authorized representative that the product in question conforms to all the applicable provisions including the conformity assessment procedures.

IEC CB TEST CERTIFICATE		Ref. Certificate No.
		NL-14196/A1
IEC SYSTEM FOR MUTUAL RECOGNITION OF TEST CERTIFICATES FOR ELECTRICAL EQUIPMENT (IECEE) CB SCHEME		
Issued by:	KEMA Quality B.V.	
Product:	Moulded case circuit-breaker	
Applicant:	LS Industrial Systems Co., Ltd.	1026-6, Hoggie-dong, Dong-an-gu Anyang-si, Gyeonggi-do Korea, Republic of
Manufacturer:	LS Industrial Systems Co., Ltd.	1026-6, Hoggie-dong, Dong-an-gu Anyang-si, Gyeonggi-do Korea, Republic of
Factory:	LS Industrial Systems Co., Ltd. Cheongju Plant	1, Songjeong-dong, Heungdeok-gu Cheongju-si, Chungcheongbuk-do Korea, Republic of
Rating and principal characteristics:	3 poles MCCB (thermal/magnetic) In = 15, 20, 30, 40, 50, 60, 75, 100, 125 A Ue = 220, 240, 250, 415, 440, 460 Vac Ui = 750 Vac Uimp = 8 kV Icu = 100 kA at 220, 240, 250 V and 50 kA at 415, 440, 460 V, Ics = 100%Icu Rated frequency = 50/60 Hz Cat A.	
Trade mark (if any):	LS	
Model/Type reference:	ABH53c, ABS103c, ABH103c	
Additional information:	WMT procedure	
Sample of product tested to be in conformity with IEC:	60947-2(ed.4)	
Test Report Ref. No.:	2109959.51 (156 pages)	
This CB Test Certificate is issued by the National Certification Body:		
KEMA Quality B.V. Utrechtseweg 310 P.O. Box 5185 6802 ED Arnhem The Netherlands		 Signed by: H.L. Schendstok Date of issue: 2008-05-21

IEC CB TEST CERTIFICATE		Ref. Certificate No.
		NL-14216/A2
IEC SYSTEM FOR MUTUAL RECOGNITION OF TEST CERTIFICATES FOR ELECTRICAL EQUIPMENT (IECEE) CB SCHEME		
Issued by:	KEMA Quality B.V.	
Product:	Moulded case circuit-breaker (earth leakage circuit-breaker)	
Applicant:	LS Industrial Systems Co., Ltd.	1026-6, Hoggie-dong, Dong-an-gu Anyang-si, Gyeonggi-do Korea, Republic of
Manufacturer:	LS Industrial Systems Co., Ltd.	1026-6, Hoggie-dong, Dong-an-gu Anyang-si, Gyeonggi-do Korea, Republic of
Factory:	LS Industrial Systems Co., Ltd. Cheongju Plant	1, Songjeong-dong, Heungdeok-gu Cheongju-si, Chungcheongbuk-do Korea, Republic of
Rating and principal characteristics:	3 pole Earth leakage circuit-breaker (thermal/magnetic with electronic ground fault detection: 30 mA, 100/200/500 mA) In = 15, 20, 30, 40, 50, 60, 75, 100 and 125A Ue = 220, 240, 250 and 415, 440, 460 Vac Ui = 460 Vac Uimp = 8 kV Icu = 100 kA at 220, 240, 250 V and Iou = 50 kA at 415, 440, 460 V Ics = 100%Icu Rated frequency = 50/60 Hz Cat A	
Trade mark (if any):	LS	
Model/Type reference:	EBS 103c, EBH 53c, EBH103c	
Additional information:	WMT procedure	
Sample of product tested to be in conformity with IEC:	60947-2(ed.4)	
Test Report Ref. No.:	2109959.54	
This CB Test Certificate is issued by the National Certification Body:		
KEMA Quality B.V. Utrechtseweg 310 P.O. Box 5185 6802 ED Arnhem The Netherlands		 Signed by: H.L. Schendstok Date of issue: 2008-06-05

Standard use environment

Standard use environment for molded case circuit breaker

The operation characteristic of Molded Case Circuit Breaker including short-circuit, overload, endurance and insulation is often influenced largely by external environment and thus should be applied appropriately with conditions of the place where it is used taken into consideration. In particular, the operation characteristic of the circuit breaker with a thermal magnetic trip element (FTU, FMU, ATU) applied changes a bit with the ambient temperature so you have to adjust the value of power rating accordingly when it is actually in use.

- 1) Ambient temperature: Within the range of -5°C ~ $+40^{\circ}\text{C}$ (However, the average for the duration of 24 hours must not exceed 35°C .)
- 2) Relative humidity: Within the range of 45~85%
- 3) Altitude: 2,000m or less (However, if it exceeds 1,000m, atmosphere correction through humidity test and withstand voltage test can be considered.)
- 4) Atmosphere where excessive steam, oil steam, smoke, dust, salt, conductive powder and other corrosive materials do not exist

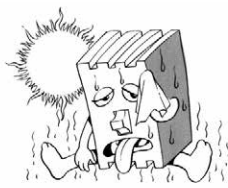

- If a standard circuit breaker is used in high temperature exceeding 40°C , you are advised to use it according to the current corrected for each level of ambient temperature in catalog.
- If used in conditions of highly humidity, the dielectric strength or electric performance may be degraded.



- There is no problem in conduction switch, trip or short circuit isolation in the temperature of -20°C .
- Passing or storage in stone-cold area is allowed in the temperature of 40°C .
- The operating characteristic of the breaker with a thermal magnetic trip element changes as the base ambient temperature is adjusted to 40°C .

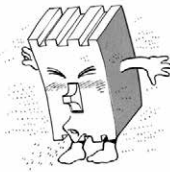

- It is highly recommended to use a dust cover or anti-humid agent if it is used in dusty and humid conditions.
- Excessive vibration may cause a trip break such as connection fault or flaw on mechanical parts.



- If it is left On or Off for a long time, it is recommended to switch load current on a regular basis.
- It is recommend to put it in the sealed protection if corrosive gas is prevalent.

Special use environment

Environment where ambient temperature exceeds 40°C

The temperature of each module of a Molded Case Circuit Breaker is the sum of temperature increase by conduction and ambient temperature and if the ambient temperature exceeds 40°C the passing current needs to be reduced so that the temperature of such element as internal insulator of MCCB exceed the maximum allowable temperature.

The base ambient temperature of Metasol breaker is set as 40°C so if it has to be used in conditions with higher temperature than this, the rated current is required to be reduced a little as described in the table below.

Table of rated current for Metasol MCCB corrected according to ambient temperature

Ampere frame	Rated current	Model name of breaker	Rated current	Table of rated current corrected according to ambient temperature (A)							
				10°C	20°C	30°C	40°C	45°C	50°C	55°C	
30	3	ABS30c	3	3	3	3	3	3	3	3	
	5		5	5	5	5	5	5	4		
	10		10	10	10	10	10	9	9		
	15		15	15	15	15	15	14	13		
	20		20	20	20	20	19	19	18		
	30	30	30	30	30	29	28	27			
	50	40	ABN50c, ABS50c	40	40	40	40	40	39	38	36
		50		50	50	50	50	49	47	45	
	60	60	ABN60c, ABS60c	60	60	60	60	60	58	56	55
	100	75	ABN100c, ABN100e	75	75	75	75	75	73	71	68
100		100		100	100	100	97	94	91		
125	125	ABH50c, ABS125c, ABH125c, ABL125c	125	125	125	125	125	121	116	107	
250	150	ABN250c, ABS250c, ABH250c, ABL250c	150	150	150	150	150	145	140	128	
	175		175	175	175	175	169	163	150		
	200		200	200	200	200	193	186	171		
	225		225	225	225	225	217	209	193		
	250		250	250	250	250	241	233	214		
400	250	ABN400c, ABS400c, ABH400c, ABL400c	250	250	250	250	250	246	242	238	
	300		300	300	300	300	295	291	287		
	350		350	350	350	350	345	339	332		
	400		400	400	400	400	394	388	381		
800	700	ABN800c, ABS800c	700	700	700	700	700	689	679	668	
	800	ABL800c	800	800	800	800	800	788	776	764	

Special use environment

Table of rated current for Metasol ELCB corrected according to ambient temperature

Ampere frame	Rated current	Model name of breaker	Rated current	Table of rated current corrected according to ambient temperature (A)							
				10℃	20℃	30℃	40℃	45℃	50℃	55℃	
30	15	EBS30c	15	15	15	15	15	15	15	15	
	20		20	20	20	20	20	19	19	18	
	30		30	30	30	30	30	29	28	27	
	50	40	EBN50c, EBS50c	40	40	40	40	40	39	38	36
		50		50	50	50	50	49	47	45	
	60	60	EBN60c, EBS60c	60	60	60	60	60	58	56	55
		75	EBN100c	75	75	75	75	75	73	71	68
	100	100		100	100	100	100	97	94	91	
125	125	EBH50c, EBS125c, EBH125c	125	125	125	125	125	121	116	107	
250	150	EBN250c, EBS250c, EBH250c	150	150	150	150	150	145	140	128	
	175		175	175	175	175	169	163	150		
	200		200	200	200	200	193	186	171		
	225		225	225	225	225	217	209	193		
	250		250	250	250	250	241	233	214		
400	250	EBN400c, EBS400c, EBH400c, EBL400c	250	250	250	250	246	242	238	238	
	300		300	300	300	295	291	287	287		
	350		350	350	350	345	339	332	332		
	400		400	400	400	394	388	381	381		
800	700	EBN800c, EBS800c	700	700	700	700	689	679	668	668	
	800	EBL800c	800	800	800	800	788	776	764	764	

Special use environment

Environment where ambient temperature is -5°C or less

Molded Case Circuit Breaker is subject to the effect of low temperature brittle of metal part inside and insulator, or changes in viscosity of lubricating oil in device, extra care should be taken not to have the temperature drop extremely with the use of such device as space heater. In addition, in case of using a thermal magnetic trip element (FTU, FMU, ATU), the operating characteristic changes toward the difficult direction, so you should identify the relationship of protection and correct accordingly.

Although MCCB is not affected by conduction switch, trip, or short circuit isolation in the temperature of -20°C, it is highly recommended to use a temperature maintaining device such as space heater. In addition, transportation and passing in stone-cold area in the temperature as low as -40°C is allowed but it is recommended to leave the status of MCCB off or tripped in order to minimize the effect of brittle due to a low temperature.

High humidity condition (Relative humidity 85% or more)

Using Molded Case Circuit Breaker in a place of high humidity requires a rigorous maintenance including installation of anti-humidity agent within the structure in order to prevent the insulation sag of insulator or corrosion of mechanical parts as a result of high humidity. Also, in case of installing MCCB within the enclosed equipment, a space heater needs to be installed as well to prevent dew condensation that might occur due to a drastic temperature change.

Environment where petrochemical gas exists

The contact material of Molded Case Circuit Breaker is silver or silver alloy which develops creation of petrochemical coat that might cause a poor connection if it gets in contact with petrochemical gas.

However, it is easy for petrochemical coat to be mechanically taken off so it is no problem if make-and-break operation occurs frequently but it needs to be switched back and forth between make and break if the operation rarely occurs.

The lead wire of moving contact of Molded Case Circuit Breaker can be disconnected as it is corroded or hardened by petrochemical gas. The silver coating is effective to prevent this from occurring and there is a need to increase durability of MCCB with the use of silver coated lead wire if it is used in environment with thick petrochemical gas.

Environment where potentially explosive gas exists

It is advised, in principle, not to install a Molded Case Circuit Breaker that switches and inhibits current in a dangerous place such as this one.

Impact of altitude

If an MCCB is used in an elevated area higher than 2000m sea level, its operating performance is subject to dramatic drop in atmospheric pressure and temperature. For example, the air pressure is reduced to 80% of ordinary pressure at 2,200m and further 50% at 5,500m although the short-circuit performance is not affected. If it is used in areas of high sea level, you can do correction based on the correction parameter table in high altitude environment, as described below

* Refer to the correction parameter table in high altitude environment (ANSI C37. 29-1970)

1) How to correct voltage:

- If the rated voltage is AC 600V at 4,000m above sea level,
 $600\text{V (rated voltage)} \times 0.82 \text{ (correction parameter)} = 492\text{V}$.

2) How to correct current:

- If the rated current is AC 800A at above 4,000m sea level,
 $800\text{A (rated current)} \times 0.96 \text{ (correction parameter)} = 768\text{A}$.

[Correction parameter table for altitude]

Altitude	Voltage correction parameter	Current correction parameter
2,000m	1.00	1.00
3,000m	0.91	0.98
4,000m	0.82	0.96
5,000m	0.73	0.94
6,000m	0.65	0.92

Environment with vibration and impulse exercised

Impact of vibration and impulse

An excessive vibration and impulse may cause damage on breaker or other security problems including dynamic strength. An appropriate consideration is required to select a right MCCB for an adverse environmental stress such as this one. Moreover, this stress may incur from vibration during transportation, magnetic impulse while manipulating a switch or may be affected by equipment in surrounding area.

There is a standard call [Vibration testing method for small electric appliances] for vibration and impulse test for electric equipment and the seismic and endurance tests of Molded Case Circuit Breaker are conducted in accordance with this standard, considering the circumstance mentioned above.

Vibration

The magnitude of vibration is measured by double amplitude and frequency with the following equation with accelerator.

$$\alpha g = 0.002 \times \text{frequency (Hz)} \times \text{double amplitude (mm)}$$

* αg : Multiple of gravitational acceleration ($g = 9.8\text{m/sec}^2$)

There are three types of vibration tests including resonance test, vibration endurance test, and malfunction test as described below.

1) Resonant test

Alter the frequency of sinusoidal wave within the range of 0~55Hz gradually with 0.5~1mm of double amplitude applied to see if there is any occurrence of vibration on a specific part of MCCB.

2) Vibration endurance test

A sinusoidal wave with double amplitude of 0.5~1mm and frequency of 55Hz (Resonant frequency obtained in previous clause if there is a resonant point) is manually created to check the operational status.

3) Malfunction test

Apply vibration for 10 minutes for each condition of altering double amplitude and frequency to check if there is any malfunction in MCCB.

Impulse

The magnitude of impulse is denoted by the multiple of gravitational acceleration imposed on the equipment and part. The test is conducted through a drop impulse test.

Impact of high frequency

In case of high frequency current, you are required to reduce the rated current of the breaker with a thermal magnetic trip element embedded due to heat incurred by the skin effect of conductor and/or core loss of structure. The reduction rate varies according to the frame Size and rated current and decreases down to 70~80% at 400Hz. In addition, the core loss decreases attractive force, which leads to increase of instantaneous trip current.

* Core loss: It refers to the electrical loss in a transformer caused by magnetization of the core that changes over time and is categorized into hysteresis loss and eddy current loss.

* Hysteresis loss: It takes up the majority portion of no-load loss of electric equipment and is calculated like this.

$$P_h = \sigma f B_m n$$

B_m : Maximum value of magnetic flux density, n : constant (1.6~2.0), f : Frequency, σ : Hysteresis constant

* Eddy current: It refers to an induced electric current formed within the body of a conductor when it moves through a non-uniform or changing magnetic field. The eddy current that incurs at winding of transformer or core is considered as one of the transformer losses as a part of exciting current. It is also called 'eddy current loss'.

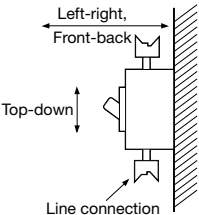
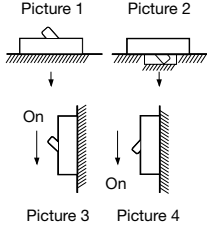

Use environment with vibration and impulse applied

[Table of seismic performance and internal impulse performance]



		Test	Internal impulse
Test condition	Mounting vibration, direction of impulse	<ul style="list-style-type: none"> Vertical mounting Top-down, Left-right, Front-back 	<ul style="list-style-type: none"> Picture 1, 2, 3, 4 (→ Represents the direction of drop) 
	Status of MCCB	(1) Non-conduction (On or Off status) (2) Status where rated current is conducted until the temperature of MCCB becomes constant and keeps being conducted	Non-conduction (On or Off status)
Test result	Judgment condition	<ul style="list-style-type: none"> If it is On, it should not be Off If it is Off, it should not be On No abnormal status such as damage, transformation, or annealing of nut part Characteristics of switch and trip after the test must be normal 	



Certifications

MCCB

Type	Approvals		Certificates
	Safet certi	IEC	KEMA
Mark and name			
Type	Korea	Europe	Netherlands
ABS32c	●	●	●
ABS33c	●	●	●
ABS34c	●	●	●
ABN52c	●	●	●
ABN53c	●	●	●
ABN54c	●	●	●
ABS52c	●	●	●
ABS53c	●	●	●
ABS54c	●	●	●
ABN62c	●	●	●
ABN63c	●	●	●
ABN64c	●	●	●
ABS62c	●	●	●
ABS63c	●	●	●
ABS64c	●	●	●
ABN102c	●	●	●
ABN103c	●	●	●
ABN104c	●	●	●
ABS32d	●	●	●
ABS33d	●	●	●
ABS34d	●	●	●
ABN52d	●	●	●
ABN53d	●	●	●
ABN54d	●	●	●
ABS52d	●	●	●
ABS53d	●	●	●
ABS54d	●	●	●
ABN62d	●	●	●
ABN63d	●	●	●
ABN64d	●	●	●
ABS62d	●	●	●
ABS63d	●	●	●
ABS64d	●	●	●
ABN102d	●	●	●
ABN103d	●	●	●
ABN104d	●	●	●
ABP52c	●	●	●
ABP53c	●	●	●
ABP54c	●	●	●
ABH52c	●	●	●
ABH53c	●	●	●
ABH54c	●	●	●
ABS102c	●	●	●
ABS103c	●	●	●
ABS104c	●	●	●
ABP102c	●	●	●
ABP103c	●	●	●

ELCB

Type	Approvals		Certificates
	Safet certi	IEC	KEMA
Mark and name			
Type	Korea	Europe	Netherlands
ABP104c	●	●	●
ABH102c	●	●	●
ABH103c	●	●	●
ABH104c	●	●	●
ABN202c	●	●	●
ABN203c	●	●	●
ABN204c	●	●	●
ABS202c	●	●	●
ABS203c	●	●	●
ABS204c	●	●	●
ABP202c	●	●	●
ABP203c	●	●	●
ABP204c	●	●	●
ABH202c	●	●	●
ABH203c	●	●	●
ABH204c	●	●	●
ABN402c	●	●	●
ABN403c	●	●	●
ABN404c	●	●	●
ABS402c	●	●	●
ABS403c	●	●	●
ABS404c	●	●	●
ABH402c	●	●	●
ABH403c	●	●	●
ABH404c	●	●	●
ABL402c	●	●	●
ABL403c	●	●	●
ABL404c	●	●	●
ABN602c		●	●
ABN603c		●	●
ABN604c		●	●
ABS602c		●	●
ABS603c		●	●
ABS604c		●	●
ABL602c		●	●
ABL603c		●	●
ABL604c		●	●
ABN802c		●	●
ABN803c		●	●
ABN804c		●	●
ABS802c		●	●
ABS803c		●	●
ABS804c		●	●
ABL802c		●	●
ABL803c		●	●
ABL804c		●	●

Type	Approvals		Certificates
	Safet certi	IEC	KEMA
Mark and name			
Type	Korea	Europe	Netherlands
EBS32c	●	●	●
EBS33c	●	●	●
EBS34c	●	●	●
EBN52c	●	●	●
EBN53c	●	●	●
EBS53c	●	●	●
EBS54c	●	●	●
EBN63c	●	●	●
EBS63c	●	●	●
EBS64c	●	●	●
EBN102c	●	●	●
EBN103c	●	●	●
EBN104c	●	●	●
EBS33d	●	●	●
EBS34d	●	●	●
EBN52d	●	●	●
EBN53d	●	●	●
EBS53d	●	●	●
EBS54d	●	●	●
EBN63d	●	●	●
EBS63d	●	●	●
EBS64d	●	●	●
EBN102d	●	●	●
EBN103d	●	●	●
EBN104d	●	●	●
EBP53c	●	●	●
EBP54c	●	●	●
EBH53c	●	●	●
EBH54c	●	●	●
EBS103c	●	●	●
EBS104c	●	●	●
EBP103c	●	●	●
EBP104c	●	●	●
EBH103c	●	●	●
EBH104c	●	●	●
EBN202c	●	●	●
EBN203c	●	●	●
EBS203c	●	●	●
EBS204c	●	●	●
EBP203c	●	●	●
EBP204c	●	●	●
EBH203c	●	●	●
EBH204c	●	●	●

Note: ● (Completion)

Memo

Global Network

LSIS is engaged in business all over the world. LSIS global network includes 7 overseas corporations, 12 overseas branches, and 224 clients in 77 countries.



► R&D



R&D campus

Focuses on gaining competitive advantages through development of next generation platforms



Power device R&D center

Leading technology in electric industry and continuously developing future-growth dynamic engines



Automation R&D Center

Serves as the main research institute for LSIS



PT&T (Testing laboratory)

Internationally-renowned testing center that has formed partnerships with the UL, CE, KEMA and CESI

► Factory



Cheongju factory (Korea)

Electric products, mold TR, MV/LV switchgear, HV GIS



Cheonan factory (Korea)
PLC, AC drive, HMI, DCS, PV module



Busan factory (Korea)
HV TR, HVDC, FACTS



Wuxi factory (China)
Electric products



Dalian factory (China)
MV/LV switchgear, MV contactor



Hanoi factory (Vietnam)
MV/LV switchgear, Mold TR



Safety Instructions

- For your safety, please read user's manual thoroughly before operating.
- Contact the nearest authorized service facility for examination, repair, or adjustment.
- Please contact qualified service technician when you need maintenance. Do not disassemble or repair by yourself!
- Any maintenance and inspection shall be performed by the personnel having expertise concerned.



- According to The WEEE Directive, please do not discard the device with your household waste.



www.lsis.com

■ Head Quarter

127 LS-ro (Hogye-dong) Dongan-gu, Anyang-si,
Gyeonggi-Do, 14119, Korea
Tel. 82-2-2034-4848, 4671, 4429 Fax: 82-2-2034-4555

■ Overseas Subsidiaries

- **LSIS(Dalian) Co., Ltd.** (Dalian, China)
Tel: 86-411-8730-7510 Fax: 86-411-8730-7560 E-Mail: dskim@lsis.com
- **LSIS(Wuxi) Co., Ltd.** (Wuxi, China)
Tel: 86-510-8534-6666-8005 Fax: 86-510-8534-4078 E-Mail: sojin@lsis.com
- **LS VINA Industrial Systems Co., Ltd** (Hanoi, Vietnam)
Tel: 84-24-3882-0222 Fax: 84-24-3882-0220 E-Mail: jhchoi4@lsis.com
- **LSIS Middle East FZE** (Dubai, U.A.E.)
Tel: 971-4-886-5360 Fax: 971-4-886-5361 E-Mail: hschoib@lsis.com
- **LSIS Europe B.V.** (Amsterdam, Netherlands)
Tel: 31-20-654-1420 Fax: 31-20-654-1429 E-Mail: htha@lsis.com
- **LSIS Japan Co., Ltd.** (Tokyo, Japan)
Tel: 81-3-6268-8241 Fax: 81-3-6268-8240 E-Mail: bmin@lsis.com
- **LSIS USA Inc.** (Chicago, U.S.A)
Tel: 1-800-891-2941 Fax: 1-847-383-6543 E-Mail: sales.us@lsis.com



Technical Question or After-sales Service

Customer Center-Quick Responsive Service, Excellent technical support | **82-1644-5481**

■ Overseas Branches

- **LSIS Shanghai Office** (China)
Tel: 86-21-5237-9977 Fax: 86-21-5237-7189
- **LSIS Beijing Office** (China)
Tel: 86-10-5761-3127 Fax: 86-10-5761-3128 E-Mail: htroh@lsis.com
- **LSIS Guangzhou Office** (China)
Tel: 86-20-8326-6784 Fax: 80-20-8326-6287 E-Mail: sojhtroh@lsis.com
- **LSIS Qingdao Office** (China)
Tel: 86-532-8501-6058 Fax: 86-532-8501-6057 E-Mail: htroh@lsis.com
- **LSIS Chengdu Office** (China)
Tel: 86-28-8670-3200 Fax: 86-28-8670-3203 E-Mail: yangcf@lsis.com
- **LSIS ShenYang Office** (China)
Tel: 86-24-2321-9050 Fax: 86-24-8386-7210 E-Mail: yangcf@lsis.com
- **LSIS Jinan Office** (China)
Tel: 86-531-8699-7826 Fax: 86-531-8697-7628 E-Mail: yangcf@lsis.com
- **LSIS Co., Ltd. Tokyo Office** (Japan)
Tel: 81-3-6268-8241 Fax: 81-3-6268-8240 E-Mail: jschuna@lsis.com
- **LSIS Co., Ltd. Rep. Office** (Vietnam)
Tel: 84-28-3823-7890 E-Mail: sjbaik@lsis.com
- **LSIS Moscow Office** (Russia)
Tel: 7-499-682-6130 E-Mail: jdpark1@lsis.com
- **LSIS Jakarta Office** (Indonesia)
Tel: 62-21-2933-7614 E-Mail: dioh@lsis.com
- **LSIS Bangkok Office** (Thailand)
Tel: 66-90-950-9683 E-Mail: sjleet@lsis.com