

DP01-72



Digital Protector Voltage – Current and Frequency control



AREAS OF OPERATION:

- In-Elevator motors protection
- On-pump and electric motor
- Resistance in oven with

V_{L1}, V_{L2}, V_{L3}
 $V_{L12}, V_{L23}, V_{L13}$
 I_{L1}, I_{L2}, I_{L3}
 Hz

Phase Sequence Control

Over Voltage Protection

Under Voltage Protection

Unbalanced Voltage Protection

Over Current Protection

Under Current Protection

Unbalanced Current Protection

Over Frequency Protection

Under Frequency Protection

Latch Function

TRUE RMS

General:

In three phase systems, it measures RMS values of AC voltages, currents and system frequency sensitively. Using up direction button (Select) phase-neutral voltages and phase-phase voltages monitor sequentially.

DP01-72 has many features.

Those are;

- Phase Failure
- Phase Sequence
- Over Voltage Protection
- Under Voltage Protection
- Voltage Unbalance (asymmetry) Protection
- Over Current Protection
- Under Current Protection
- Current Unbalance (asymmetry) Protection
- Over Frequency Protection
- Under Frequency Protection

- (seq)
- (seq)
- (o - U)
- (u - U)
- (unb)
- (o - C)
- (u - C)
- (ubC)
- (o - F)
- (u - F)

When device is turn on if its adjusted voltages and frequency in its interval and if phase sequence is correct relay switch on.

If any of error occurred (except phase failure and phase sequence) at the end of adjusted time relay switch off its contact. When system return normal values, at the end of time out relay switch on.



IMPORTANT: L1 - N is device supply inputs. Thus, the applied L1 – N voltage must be rated voltage of system. Otherwise normal led makes flash and the device switched off its output contact.

The measured frequency also must the frequency of the system.

Phase Failure: (u-U)

Before starting system, it controls phase absence then if all phases exits Normal LED turn on and relay contact switch on. In case of missing of any L1, L2, L3 phases, Normal LED turn off and relay switch off its contact. In this case u-U warn appears on display.

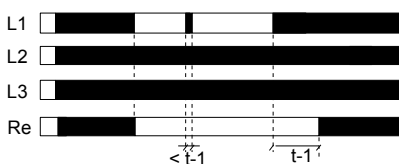

Display Functions:

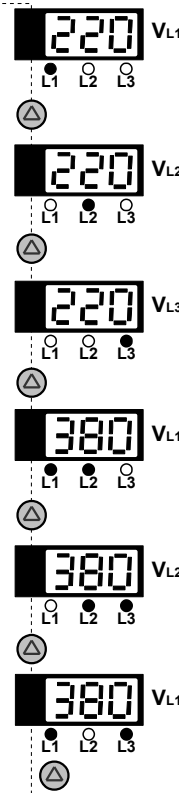

Special Buttons:

Select: (Up direction) when pressing continuously, screen displays frequency of system. When button release device continue to show voltage.

Reset: If error case although disappeared then device is not return to normal, latch-function occurred and it makes locked device. Or Lock-function (only for currents) may be occurred. After checking error in system then restart device with pushing reset button.

Phase Sequention: (Seq)

In case of wrong phase order, Normal LED turned off and relay contact is not switch on. In this case seq warn appears on the screen. If phase order is corrected, Normal LED turned on and out relay switch on.

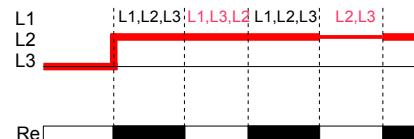

Voltage Unbalanced: (unb)

The phase-phase voltage unbalance limit can be adjusted between (5% - 20%). When it exceeds the adjusted limit, the device switched off its out contact at the end of t-1 delay. In this case unb warn appears on the screen. For the returning normal state, asymmetry values should under 20% (hysteresis value). In this case at the end of t3 time Normal LED turned on and output contact switch on. If the phase-phase voltage unbalance, return adjusted value shorter than t-1 time, output relay does not release its contact. Hysteresis is 20%.

unb = 000(oFF) protection is disable.

Example: Let's say that asymmetry value is set to %15 for a 3 x 380VAC.

In this case, relay contact switch off at $(380 - (380 \times 0.15)) = 323$ V. Switch on the contact is performed at $323 + (380 \times 0.15 \times 20) = 334$ V. (%20 is the hysteresis).

$$\% \text{ unb} = \frac{(V_{\max} - V_{\min})}{380} \times 100$$

$$\text{Hys} = 380 \times (\% \text{ Asm}) \times (\% 20)$$

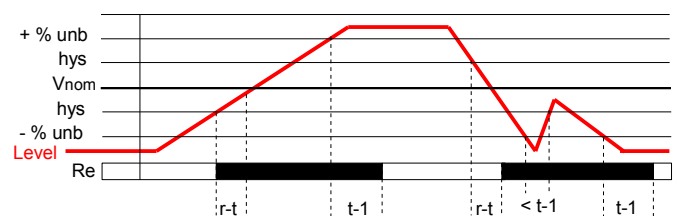

Over and Under Voltage : (o-U),(u-U)

Under voltage (u-U) it can adjusted between $U_{min}=(300 - 370 V)$.
 Over voltage (o-U) it can adjusted between $U_{max}=(390 - 460 V)$.
 If the voltage drops below the adjusted under voltage limit, when **u-U** shows on the screen and device switch off its output contact end of the t-1 time Normal LED turned on .In this case **u-U** warn appears on the screen.
 If the voltage exceed the adjusted over voltage limit, Normal LED turned off and output relay switch off. In this case **o-U** warn appers on its screen.
 Hysteresis is 6 V.

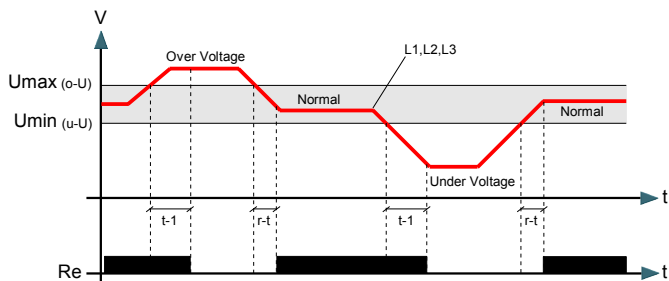

Over and Under Current : (o-C),(u-C)

Under Current (u-C)
 Over Current (o-C)
 When the current of the protected system goes below the adjusted value it switches off its output contact after **d-t** delay.
 Normal LED turn off and relay switch off its contact .In this case **u-C** warn appears on display.
 When any current passing through any phase of the protected system exceeds the adjusted value the device switches off its output contacts after a proper time (**d-t**).Normal LED turn off and relay switch off its contact .In this case **o-C** warn appears on display.

NOTE: Under current protection set value with its hysteresis must not overlap with over current protection set value with its hysteresis or, the under current protection set value must not be higher than the over current protection set value.

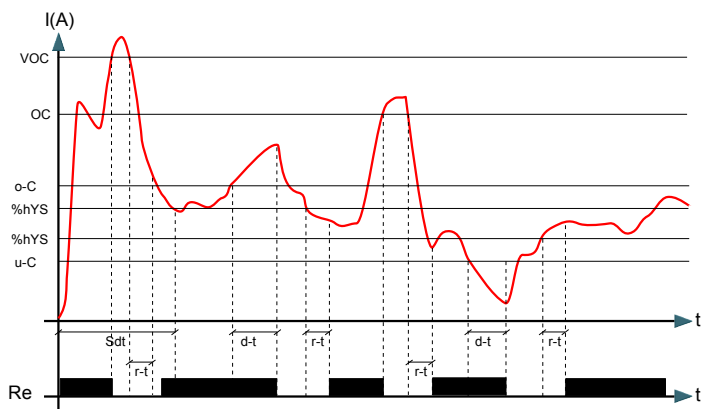

Start delay time: Sd-t

It can be set between 1 and 60 seconds.It is used to prevent the switch off from occurance because of the motor's inrush current.
 This function can be disable if Sd-t value = 000 (oFF)

Return Time : r-t

it shows the delay time that device will wait to switch on its output relay when failure ends after a switch off. It can be set between 0,5 and 99,9 seconds.

Very Over Current Coefficient : VOC (Current Very Sudden Switch Off Protection)

It can be set by the user between 2,1 and 6.
 When the current value exceeds the adjusted value within the start delay time, the device switches off, its output contact immediately.
 Very Over Current value = $(o - C) \times (VOC)$
 This function can be disable if VOC = 000 (oFF)

Over Current Coefficient : OC (Current Sudden Switch Off Protection)

It can be set by the user between 1,1 and 2.
 When the current value exceeds the adjusted value without the start delay time, the device switches off, its output contact immediately.
 Over Current value = $(o - C) \times (OC)$
 This function can be disable if OC = 000 (oFF)

2.6 Asymmetric Current Protection:

It can be set by the user between 5% and 40%. It controls the asymmetric that may occur in the current of the three phases. That may occur when one of the phases' voltage is low and the other one is high. That may cause asymmetric current in the motor's bobbin. This way the motor's bobbin is protected. Furthermore it protects the motor from missing phase or a possible unplugged or cut wiring. If the unbalance between the phases' current exceeds the adjusted value the switch off occurs after t-1 delay.
 If the current unbalance exceed the adjusted value, Normal LED turned off and output relay switch off. In this case **ubC** warn appears on its screen.
 This function can be disable if **ubC** value = 000 (oFF)

Over and/or Under Frequency Protection : (40 – 70 Hz)

Under Frequency be able to set between $(u-F) = 40 Hz \dots [(o-F) - 0,4]$
 Over Frequency be able to set between $(o-F) = [(u-F) + 0,4] \dots 70 Hz$
 If required , it can be set only under frequency or only over frequency protection as well as both of protection can be disabled.
 • If o-F = 55 Hz and u-F = oFF set, device works as over frequency protector only. (if system frequency above 55 Hz, under screen displays **o-F** warning and end of time t-2 relay switch off its output contact)
 • if o-F = oFF and u-F = 45 Hz set , device works as under frequency protector only . (if system frequency below 45 Hz, under screen displays **u-F** warning and end of time t-2 relay switch off its out contact.)
 • if o-F = oFF and u-F = oFF set, frequency protection is disabled.

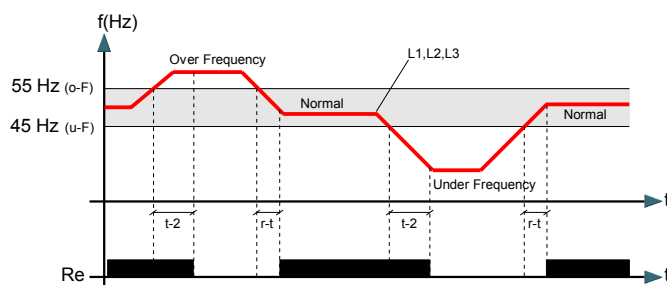

LOCKING FUNCTION :

It can be controlled by two parameters. Locking time and Locking counter. If the number of opening reaches the adjusted locking counter withing the adjusted locking time then device switch off its contact and locks its functions until the user pressed **Reset** button.

If the locking counter is adjusted to **oto** then this function is disable and device never locks itself.

L-t : Locking Time (001 – 060 min.)

It is well know the frequently occurring faults may damage system. For that the device when number of faults reaches the adjusted locking number within this locking time. This way the system is protected and user has chance to investigate the problem.

L-C : Locking Counter (oto , 001 – 010 piece)

The number of faults allowed within the period L-t. If number of faults exceeds this adjusted counter value device locks itself. In this case (---) warn appears on its screen. User must press **Reset** button then the fault passes in order to unlock the device. If **L- C** is set to **oto** then this property is disabled.

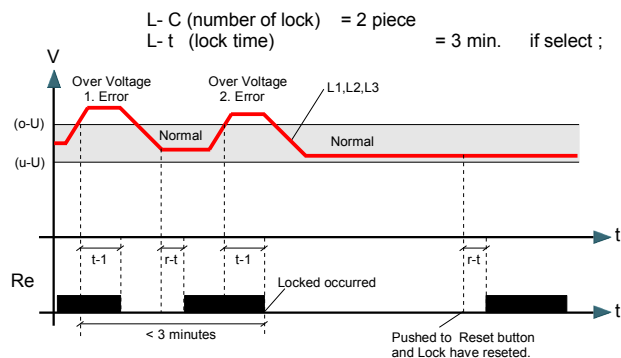

ACCESSING PARAMETER MENU:

Push the SET button during 3 seconds.

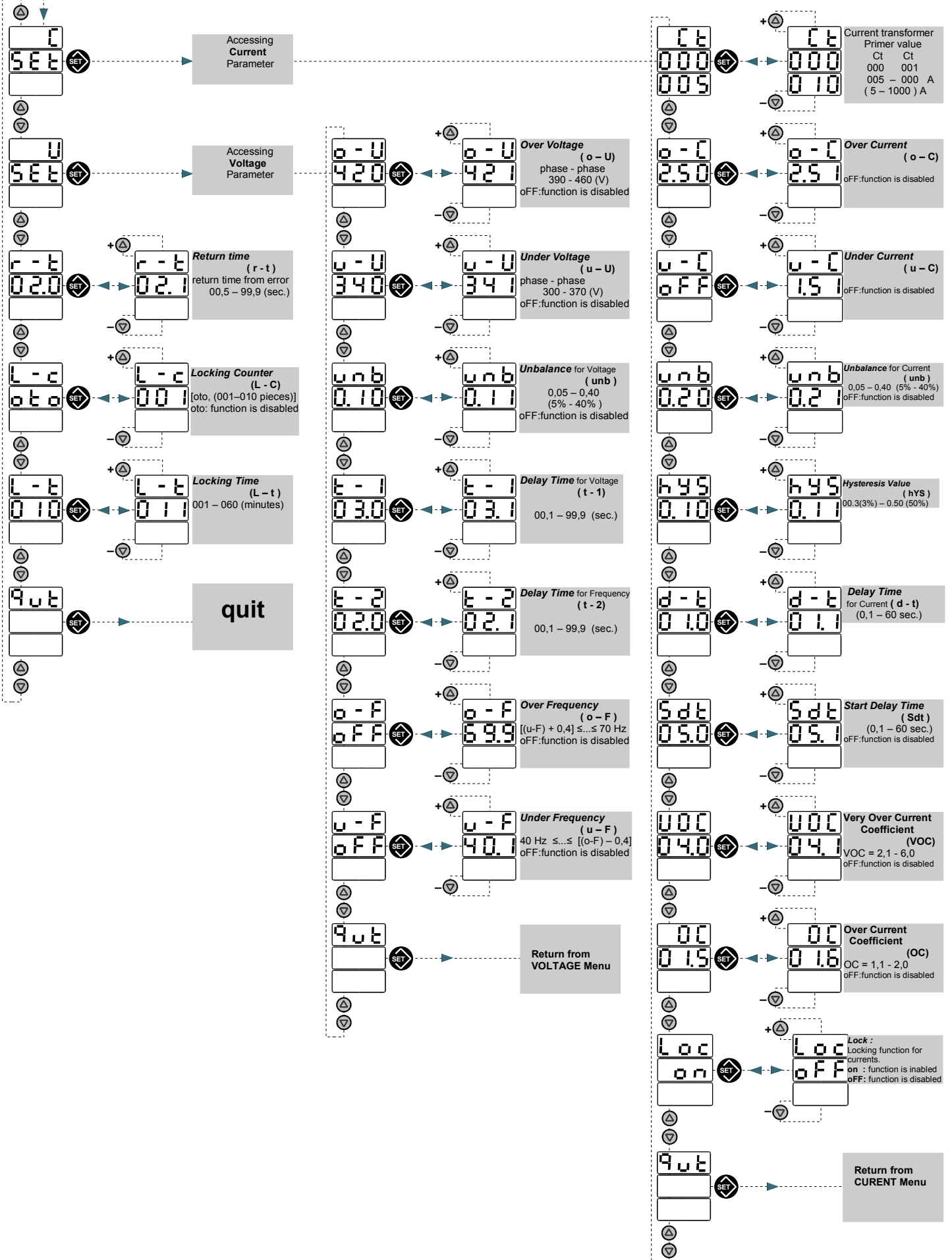

Connection :

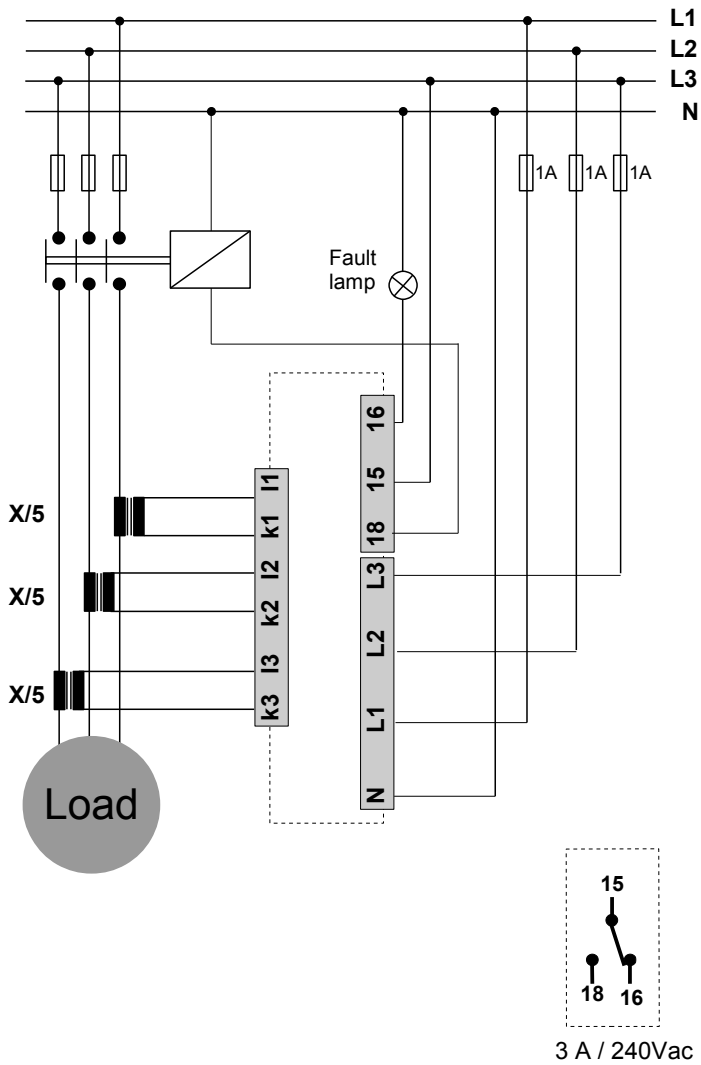

3 A / 240Vac

TECHNICAL INFORMATION:

Rated Voltage (Un)	: 230Vac (L1-N)
Operating Range	: (0,8-1,1) x Un
Frequency	: 50 / 60 Hz
Supply Power Consumption	: < 4VA
Current Transformer Ratio	: X / 5A
Current Measurement Range	: (for seconder current) 0,05 - 6 Amp AC
Voltage Measurement Range	: (Phase-Phase) 10 - 500 Vac, 45 - 65Hz : (Phase-Neutral) 10 - 300 Vac, 45 - 65Hz ⚠ For power supply(L1 - N) 176V – 242V
Voltage Measurement	
Power Consumption	: < 1VA (for one phase)
Measurement Sensitivity	: %1±1 digit
Contact Current	: Max. 3A / 240Vac
Device Protection Class	: IP 20
Connector Protection Class	: IP 00
Temperature	: - 5 °C + 50 °C
Connection Type	: To front panel tap
Dimensions	: 72x72x80 mm



ATTENTION !!!

- Clean the device using dry dust cloth after turned off device.
- Read and follow the instruction on this manual and attached label.