

# ke-ZRXX (D)



## Multi Function Digital Timer

- Time Interval  
0,1 ..... 9999 sec  
0,1 ..... 9999 min
- 2 Relay Output
- 19 different function
- Start Input :  
NPN with proximity sensor or switch
- Easy Programming



### For t1 Time Value Selection : 0,1 – 9999

After time unit selection when pressing down button one time then t1 value displays on the screen. Meanwhile turning on selected time unit LED and t1 LED Set LED flash. For changing value press SET button then numeric value, set LED and t1 LED start to flash. Using direction buttons come required time value and pressing SET to store value to memory.

### For t2 Time Unit Selection : Minute (min), Second(s)

If t2 using only in selected function device turn on its t2 settings. Otherwise any parameter does not return related to t2. After time values selection for t1 then when press down button displays t2-S to screen, which is related to second time(t2) unit appears. While Set LED flashes unit LED(min or s) where is memory related t2 LED with t2 time. For changing this unit press to Set button t2-S appears, set LED and unit LED flash. In this case using direction buttons proving turning on min (minute) or s( second) and repress Set stored selected time for t2.

### For t2 Time Value Selection : 0,1 – 9999

After time unit selection when down direction button press once t2's numeric values appears. Meanwhile turning on selected time unit LED and t1 LED Set LED flash. For changing value press SET button then numeric value, set LED and t2 LED start to flash. Using direction buttons come required time value and pressing SET to store value to memory.

### Storing Memory:

Press last of all down direction button and **SAVE** appears on the screen. In this case pressing Set button all data stored to memory and start work device according to function. If not press Set when device screen is **SAVE** all change cancel. Device continue to work current functions.

## General

Device is microprocessor based. Many time relay applications collect inside. Sensitively time adjustment of classic time relays cause problems, then it is developed fully digital. There are 19 different applications of functions selection inside. Moreover some applications need to start input. Because of this reason using with both NPN type proximity sensor and switch.

## Advance Programming

For safe access parameters in this section, pressing both up and down buttons during 2 sec. same time. Firstly during 1 sec **Prog** will appear then **P-...** function number will appear and set LED start to flash.

### Function Selection :

In this section determining device work in which function. Therefore need to enter number of selected function. In this section press Set button and when **P-....** flashing then using direction button come to related function number then press Set button to store.

### For t1 Time Unit Selection : Minutes (min), Second (s)

According to selected function, device accessing to t1 unit if t2 available to t2 unit decide itself. After function selection when down button pressed t1-S displayed on screen which is relating to unit of first time (t1). While Set LED flashing Unit LED where is memory related t1 LED with t1 time (min or sec) turned on. For changing this unit press to Set button. t1-S appears, Set LED and Unit LED flash. In this case using direction buttons provide turning on min(minute) or s(second) LED and repressed Set button stored selected time for t1.

Pressing both up and down buttons until Prog appears on the screen

LED denotation

- FLASH
- CONTINUOUS
- TURNED OFF

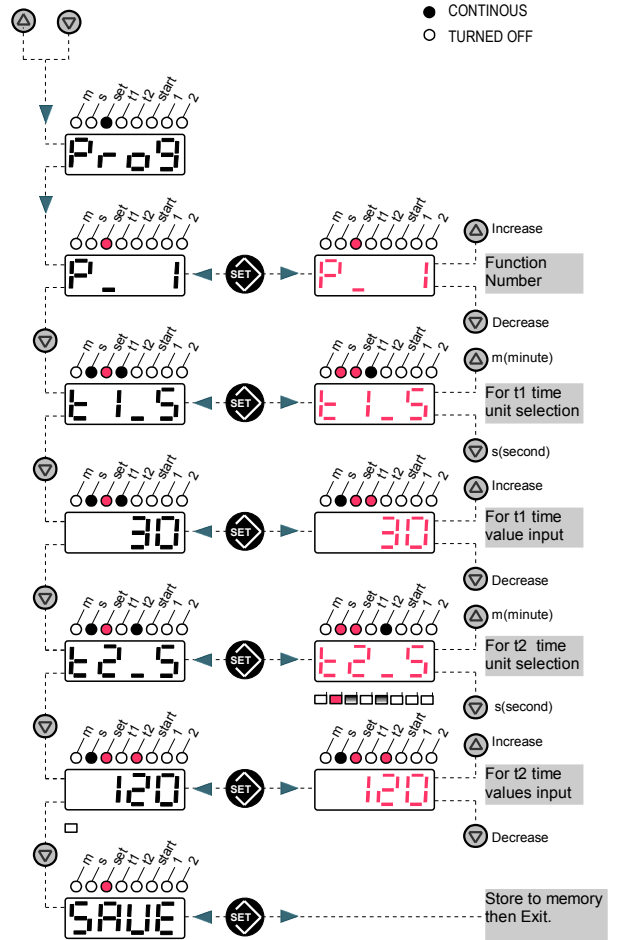

## User Menu

This is adjusting section for end-users. When device working 3 sec. Press to Set button for entering this section. t1 LED and t1 time unit LED ( second and minute) turned on, Set LED flash and t1 time related values comes to screen from memory. For changing t1 time, press to Set button t1 and set LED with values where is on screen start to flash. Using direction find required time values and press set button then quitting from t1 time adjustment. If t1 time values does not require changing, press down direction button ,if there is t2 time in selected function, t2 LED and t2 time unit (second and minute ) turn on, set LED flash and memory value comes to screen related with t2 time. For changing t2 time press set button t2 and Set LEDs with value where is on screen start to flash. Using direction button find required time and press to set button and quitting from t2 time adjustment. Therefore press down button and **SAVE** appear on the screen. In this case if press Set button all changes store to memory and device continue to work. Otherwise all changes cancel.

If function have both t1 and t2 ;

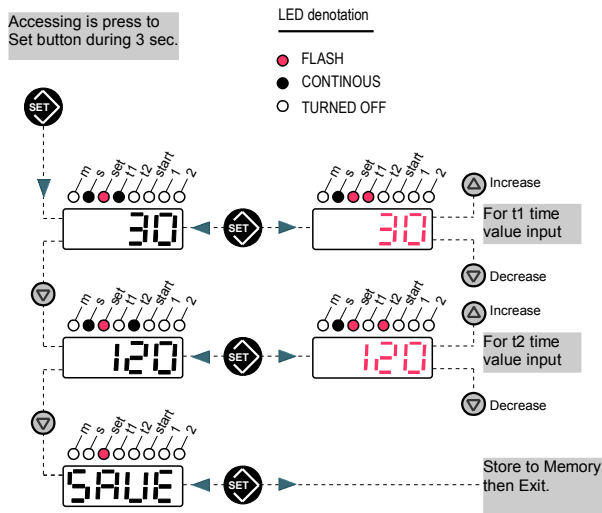

If there is only t1;

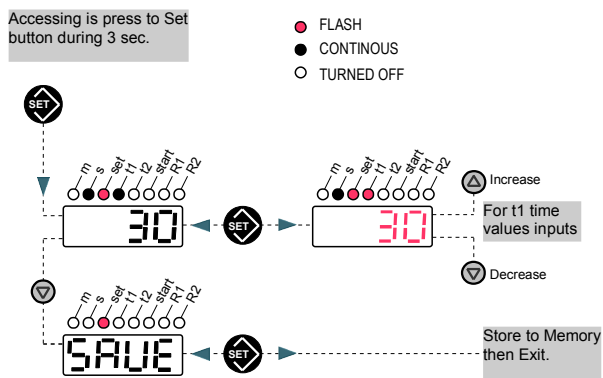

### 1) Double Time Adjustable Flasher Relay (OFF start )

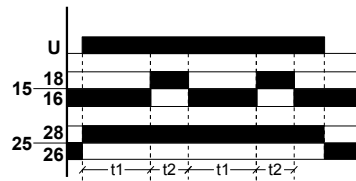

### 2) Double Time Adjustable Flasher Relay (ON start )

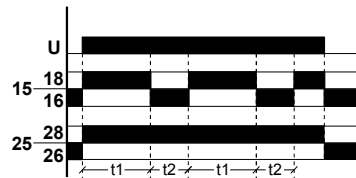

### 3) Double Time Adjustable Flasher Relay (OFF start ) Start with Start (S)

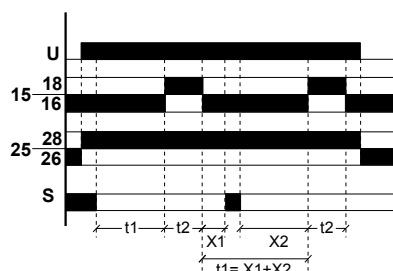

### 4) Double Time Adjustable Flasher Relay (ON start ) Start with Start (S)

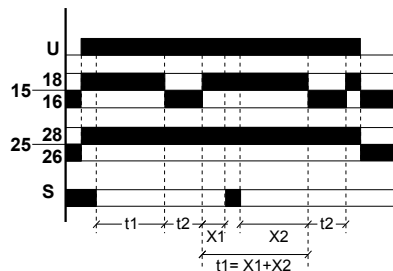

### 5) Double Time Relay(OFF start)

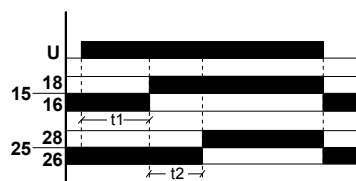

### 6) Direction Inverse Relay (ON start )

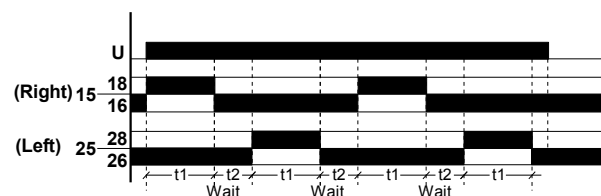

### 7) Direction Inverse Relay (ON start ) Start with Start (S)

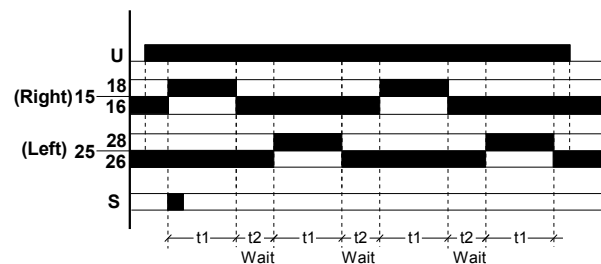

## Functions

Most used 19 application define in device memory . Suitable function number entering have discussed in advance programming section.

**8) Direction Inverse Relay (OFF start)**

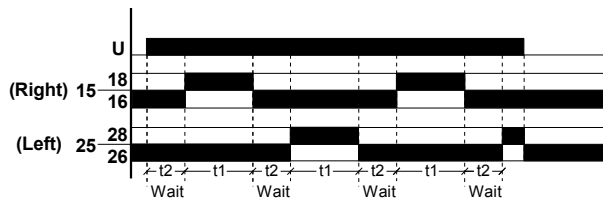

**9) Direction Inverse Relay (OFF start)  
Start with Start (S)**

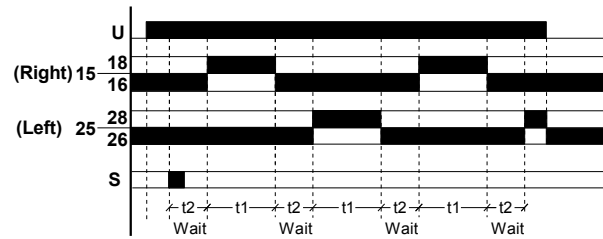

**10) On Delay Time Relay**

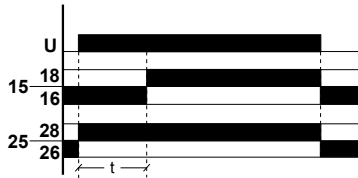

**11) On Delay Time Relay  
Start from Start (S)'s down edge**

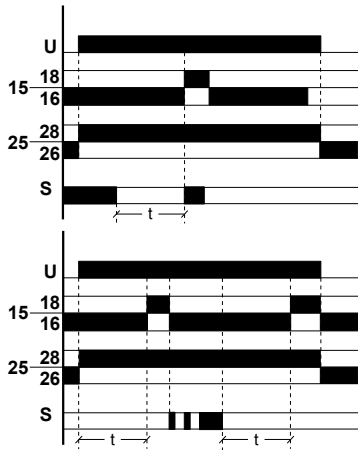

**12) Off Delayed Double Timer**



**13) Off Delay Time Relay  
Start when Start (S) remove**

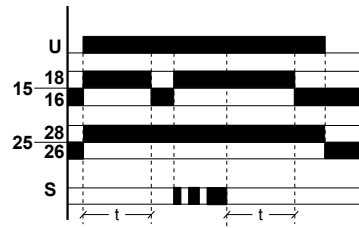
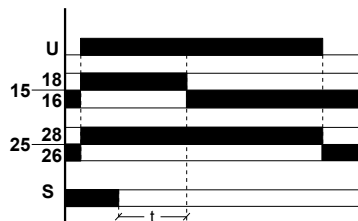

**14) Off Delay Time Relay  
Start, Start (S)'s up edge and down edge**

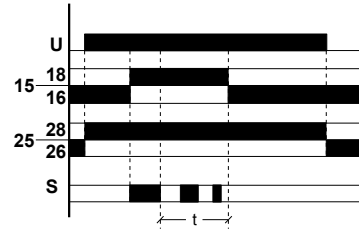

**15) Off Delay Time Relay  
Start with Start (S)**

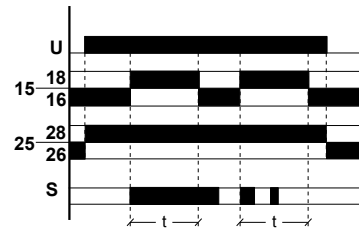

**16) Off Delay Time Relay  
Start, Start (S)'s down edge**

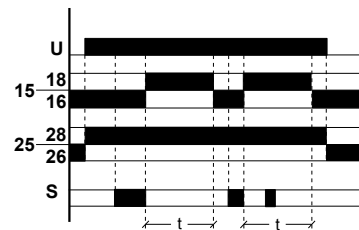

**17) On - Off Time Relay  
Start with Start (S)**

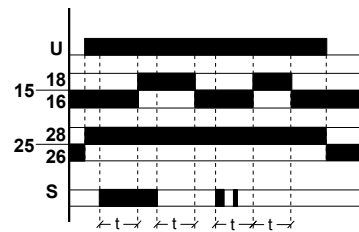

**18) Impulse Relay**

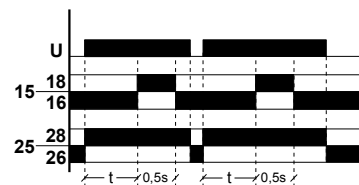

**19) Impulse Relay  
Start controlled by Start (S)'s up edge**

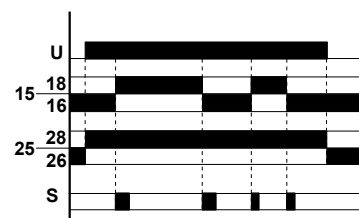

## Connection Scheme

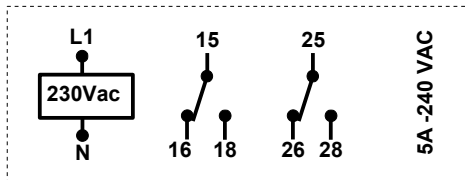
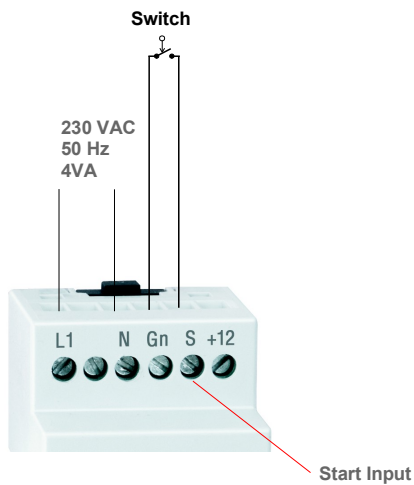
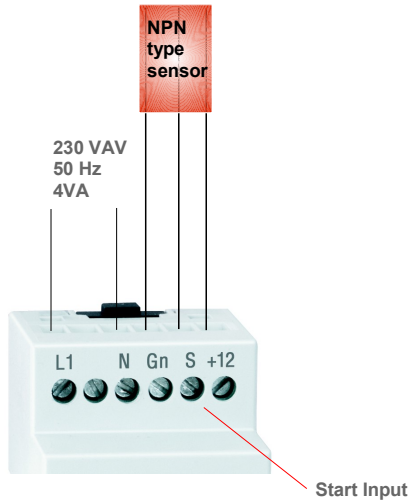

### TECHNICAL DATA:

#### Rated Voltage(Un)

L1- N terminal : 230 VAC

Operation Range : (0,8-1,1) x Un

Frequency : 50/60 Hz.

Contact Current : Max.5 A / 240 VAC

#### Power

Consumption : < 4 VA

Display : 4 Digit LED

#### Device Protection

Class : IP20

#### Connector

Protection Class : IP00

Temperature : - 5 °C.....+ 50 °C

Connection Type : To front panel tap

Dimensions :

